

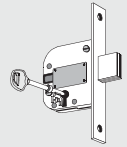

Welded keys
Chiavi saldate
Geschweisste Schlüssel
Clés soudees
Llaves soldadas
Chaves soldadas

FOR:
PER:

ASSA



189

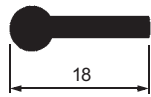
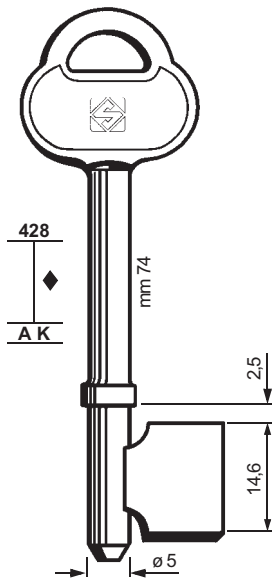

2AS1
2741

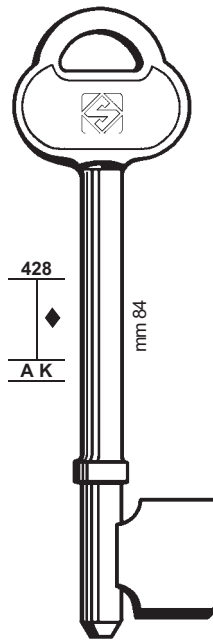

2AS2
2741

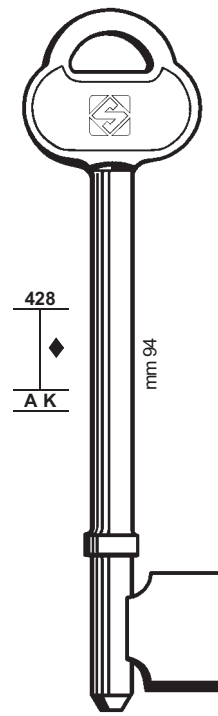

2AS3
2741

FOR:
PER:

ASSA

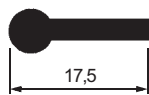
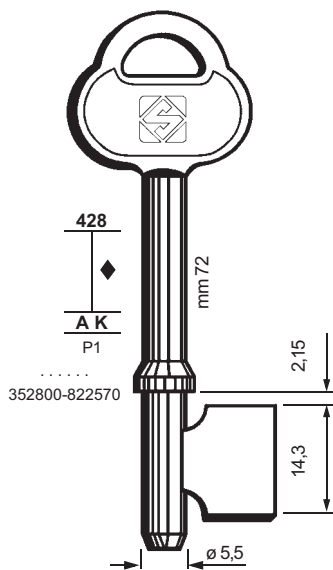

2AS4
90000

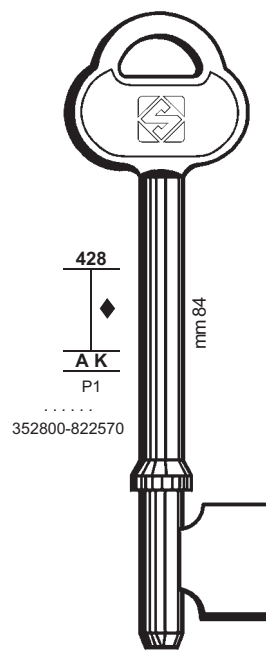

2AS5
90000

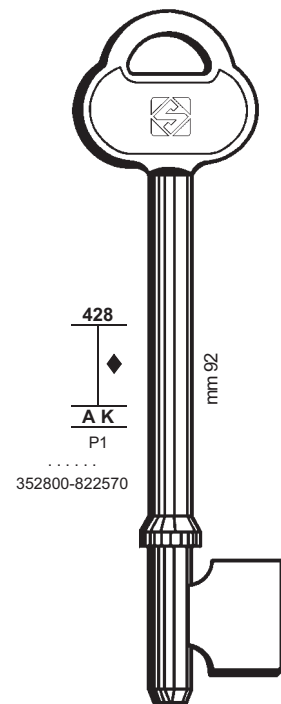

2AS6
90000

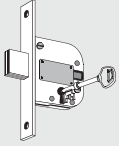

190

FOR:

PER:

ASSA

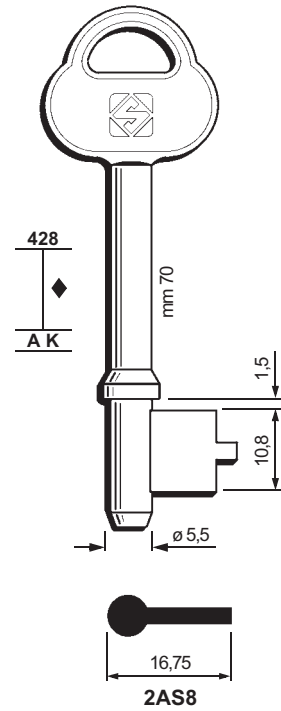
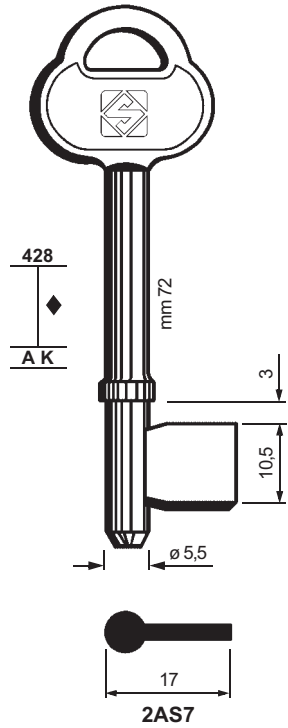

FOR:

PER:

ASSA

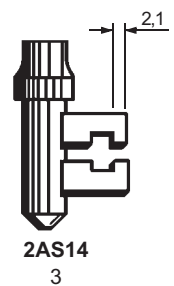
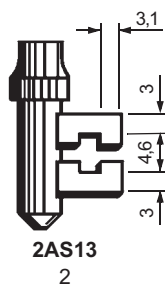
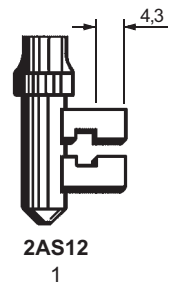
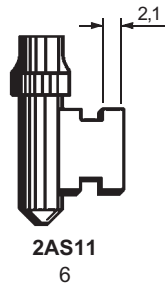
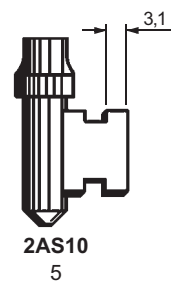
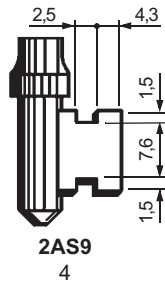
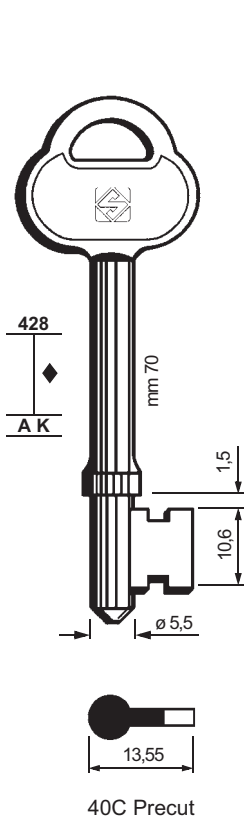

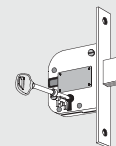

191

2AS16-...

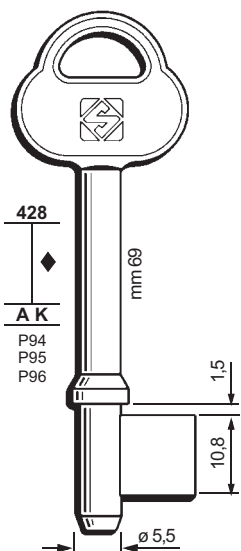

2AS16
40C Precut

- ... 1/2 131-332
- ... 1/2/3 133-333
- ... 1/2/3 311-322

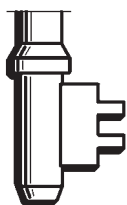

131



132

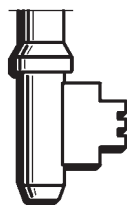

133

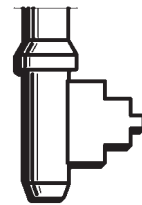

134



231



233



234

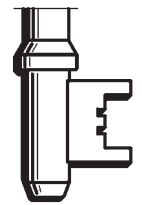

311



312



313



314



323

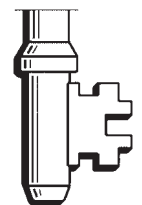

2311



2312



2321

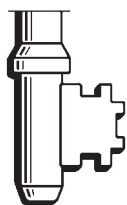

2322



2331



2341

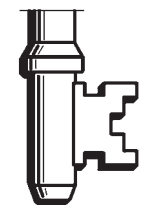

3211



3212



3231



3232



3311



3321

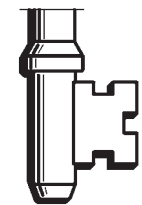

3322



3331

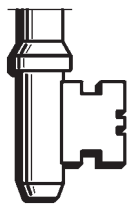

3332

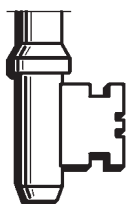

3333

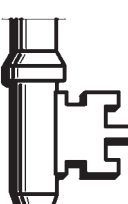

3241

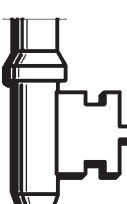

3343

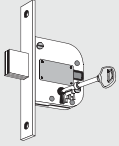

192

FOR:

PER:

ASSA

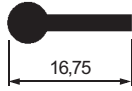
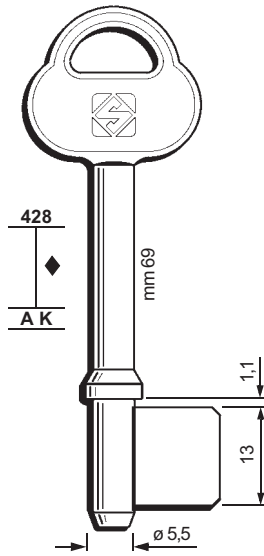

2AS18
40D Blank

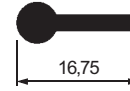
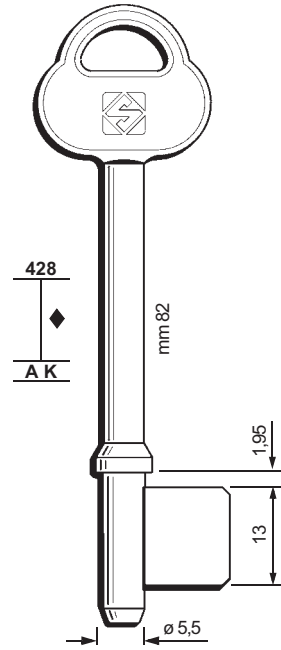

2AS19
40A/2440 Blank

FOR:

PER:

FAS - YALE

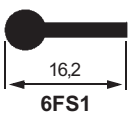
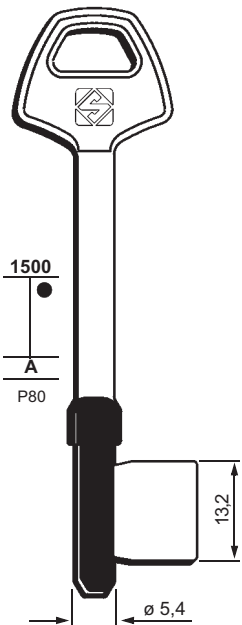

6FS1

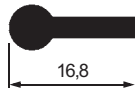
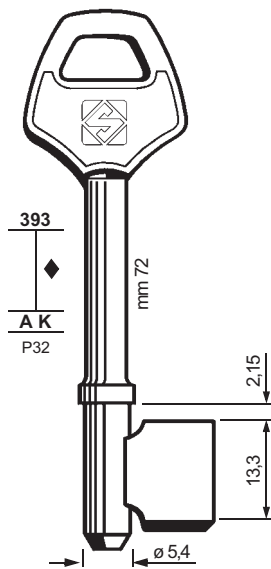

2FY1
309

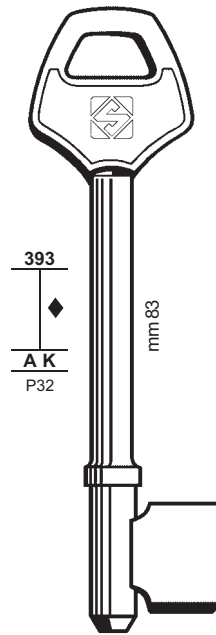

2FY2
309

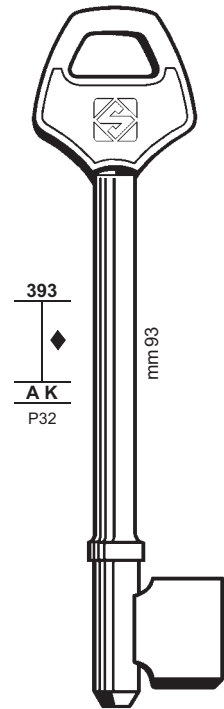

2FY3
309

FOR:
PER:

FAS - YALE

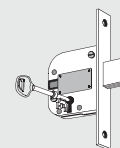

193

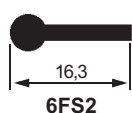
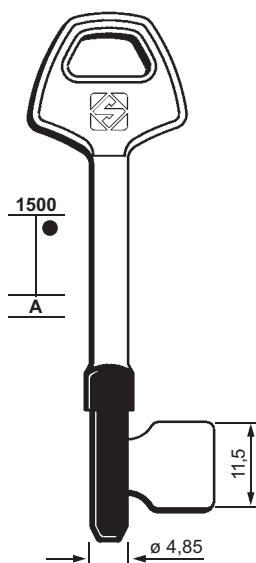

6FS2

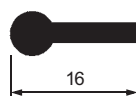
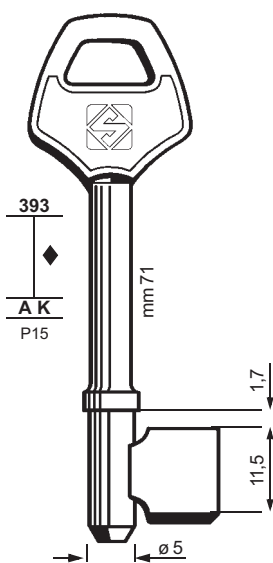

2FY4
131

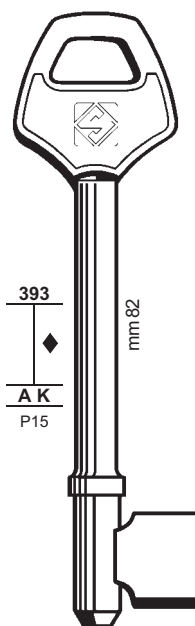

2FY5
131

FOR:
PER:

FAS - YALE

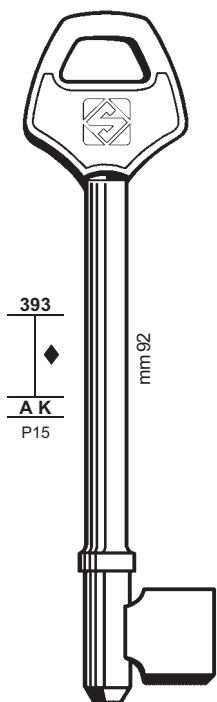

2FY6
131

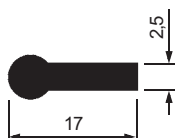
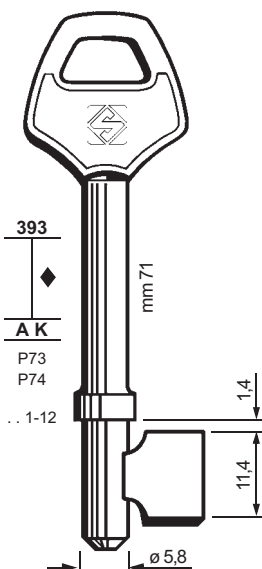

2FY7
40C

LÅSBOLAGET

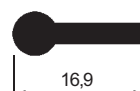
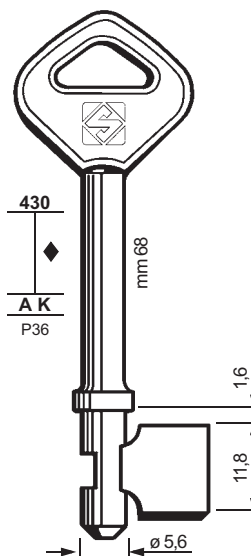

2LB1
40A/131

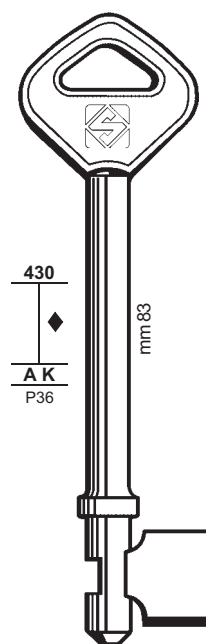

2LB2
40A/131

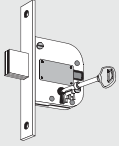

194

FOR:

PER:

LÅSBOLAGET

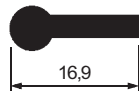
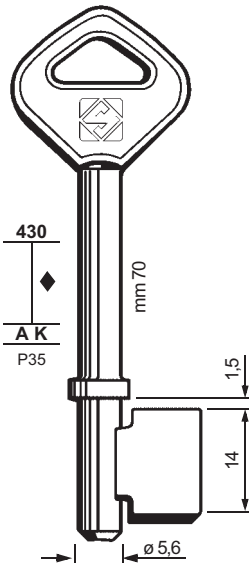

2LB4
9900

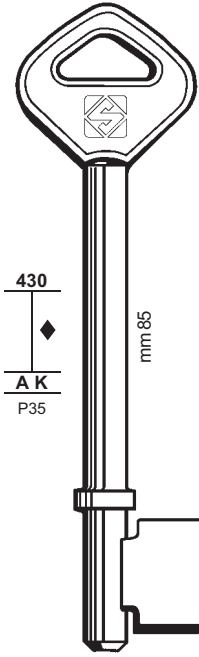

2LB5
9900

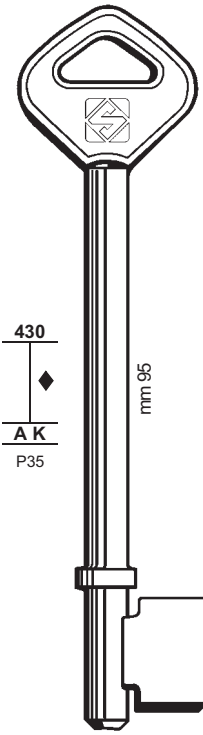

2LB6
9900

FOR:

PER:

LIPS

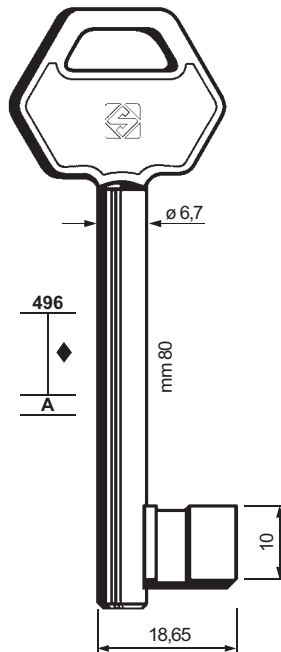

2LP2B

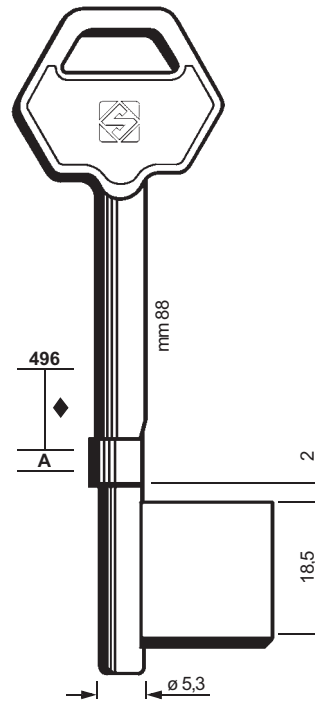

5867L



GB IMPORTANT

All information and illustrations in this catalogue are for guidance only.

Silca reserves the right to alter products designs, dimensions or info to improve the products quality.

The contents of this catalogue are fully protected by Copyright and may not be copied or reproduced in any form, without written permission from Silca.

Any infringements will be dealt with under Italian law.

I IMPORTANT

Le illustrazioni e i dati tecnici dei prodotti contenuti nel catalogo debbono considerarsi indicativi.

Silca si riserva il diritto, ferme restando le caratteristiche essenziali dei prodotti, di apportare tutte le modifiche che ritiene necessarie e opportune al fine di migliorare la qualità dei prodotti.

Tutti i disegni e le fotografie sono di proprietà di Silca, ogni riproduzione anche parziale, senza autorizzazione scritta della Silca è vietata secondo termini di legge.

Per qualsiasi controversia competenti sono gli Uffici Giudiziari dove ha sede l'Azienda, con espressa esclusione di qualsiasi altro foro.

D WICHTIG

Die Abbildungen und technischen Daten des Katalogs sind nur zur Information.

Silca behält sich vor, etwaige Änderungen am Produkt, die zur Verbesserung desselben beitragen vorzunehmen.

Alle Zeichnungen und Fotos sind Besitz der Firma Silca, jede Reproduktion, auch teilweise, ist ohne schriftliche Erlaubnis der Firma Silca gesetzlich untersagt.

Im Falle von Streitfragen ist der Gerichtshof des Firmensitzes zuständig; jeder andere Gerichtshof ist ausgeschlossen.

F IMPORTANT

Les illustrations et les caractéristiques techniques des produits présentés dans ce catalogue sont données à titre indicatif.

Bien que les caractéristiques essentielles des produits soient invariables, Silca se réserve le droit d'apporter toutes les modifications qu'elle retiendra nécessaires et opportunes afin d'améliorer la qualité de ses produits.

Tous les dessins et photos sont propriété Silca et toute reproduction, même partielle, sans l'autorisation écrite préalable de Silca est interdite conformément aux prescriptions légales. Tout litige est du ressort exclusif des Tribunaux de la circonscription où se trouve le Siège de la Société.

E IMPORTANTE

Las ilustraciones y los datos técnicos de los productos en este catálogo son indicativos.

La Silca se reserva el derecho, quedando invariadas las características principales de los productos, de modificar todo lo que considere necesario y oportuno para mejorar la calidad de sus artículos.

Todos los dibujos y las fotografías pertenecen a la Silca; según determina la Ley, se prohíbe toda reproducción aunque parcial, sin autorización por escrito de la Silca.

En caso de disputas la competencia es de las autoridades judiciales donde está domiciliada la firma, excluyendo cualquier otro foro.

P IMPORTANTE

As ilustrações e as características técnicas dos produtos apresentados neste catálogo são facultados a título indicativo.

Mesmo que as características essenciais dos produtos sejam invariáveis, à Silca reserva-se o direito de modificar ser necessário e oportuno los productos, afim de melhorar a sua qualidade.

Todos os desenhos e fotos são propriedade da Silca, e é proibida a sua reprodução mesmo parcial sem a autorização escrita da Silca conforme as prescrições legais.

Em caso de litígio fica desde já designado, excluindo qualquer outro, o Tribunal da comarca onde está registada a sede da Silca.

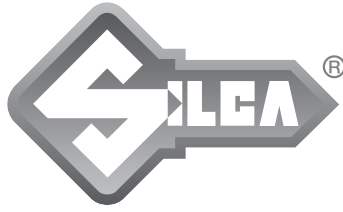
**GB IMPORTANT**

In compliance with current regulations relating to industrial property, we hereby state that the trade-marks or trade names mentioned in our catalogue are the exclusive property of authorized manufacturers of locks and users.

Said trade-marks or trade names are nominated only for the purposes of information so that any lock for which our keys are made can be rapidly identified. This catalogue is reserved exclusively for professional key cutters who use Silca products.

F IMPORTANT

Conformément aux lois en vigueur concernant la propriété industrielle, nous vous informons que les marques et appellations commerciales citées dans notre catalogue appartiennent exclusivement aux fabricants de serrures et aux utilisateurs autorisés.

Ces marques ou appellations commerciales sont indiquées à titre d'information pure et simple pour vous permettre de déterminer rapidement les serrures auxquelles nos clés sont destinées.

Ce catalogue est réservé exclusivement aux professionnels du taillage de clés qui utilisent les produits Silca.

I IMPORTANT

In conformità alle disposizioni legali in vigore relative alle proprietà industriali, informiamo che i marchi o le denominazioni commerciali citate nel nostro catalogo sono di proprietà esclusiva dei fabbricanti di serrature e degli utilizzatori autorizzati.

Questi marchi o denominazioni commerciali sono indicati a titolo di semplice informazione, con lo scopo di riconoscere velocemente a quali serrature le nostre chiavi sono destinate. Questo catalogo è esclusivamente riservato ai professionisti della riproduzione chiavi che utilizzano i prodotti Silca.

E IMPORTANTE

En conformidad con las vigentes disposiciones de ley sobre propiedad industrial, las marcas y denominaciones comerciales citadas en nuestro catálogo se declaran de propiedad exclusiva de los fabricantes de cerraduras y los utilizadores autorizados.

Dichas marcas o denominaciones comerciales se citan por simple información, al objeto de hacer comprender sin dificultad a qué cerraduras van destinadas nuestras llaves.

Este catálogo está reservado exclusivamente a los profesionales de la reproducción de llaves que utilizan los productos Silca.

D WICHTIG

Gemäß den derzeit geltenden Normen bezüglich des Industrieigentums teilen wir Ihnen mit, daß die im vorliegenden Katalog angeführten Markennamen oder Handelsmarken ausschließliches Eigentum der Schloßhersteller und zugelassenen Fachhändler sind.

Diese Markenbezeichnungen oder Handelsmarken sind nur zur Information angeführt, mit dem Zweck, schnell erkennen zu können, zu welchem Schloß unsere Schlüssel gehören.

Der vorliegende Katalog ist ausschließlich an Schlüsselkopier-Fachgeschäfte, die Silca Produkte benützen, gerichtet.

P IMPORTANTE

Em conformidade com as disposições legais em vigor relativas à propriedade industrial, informamos que as marcas ou as denominações comerciais citadas no nosso catálogo são propriedade exclusiva dos fabricantes de fechaduras e dos utilizadores autorizados.

Estas marcas ou denominações comerciais são indicadas só a nível de informação, a fim de reconhecer rapidamente a quais fechaduras se destinam as nossas chaves.

Este catálogo é reservado exclusivamente aos profissionais da reprodução de chaves que utilizam os produtos Silca.