

LANCER PLUS

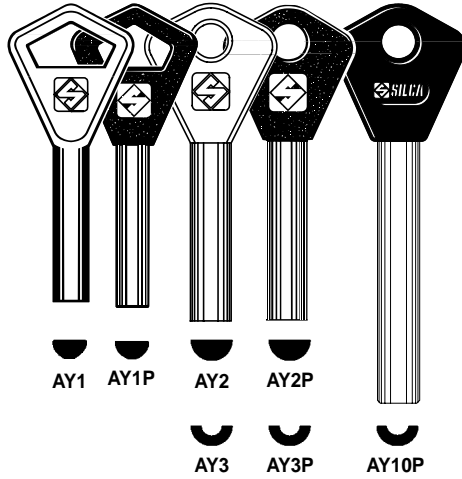

PER:
FOR: **ABLOY (S)**



OPTIONAL

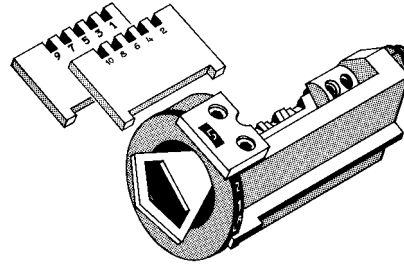

D706626ZB

Code attachment for ABLOY keys
Dispositivo a codice per chiavi ABLOY
Code-Vorrichtung für ABLOY Schlüssel
Dispositif à code pour clés ABLOY
Dispositivo a código para llaves ABLOY

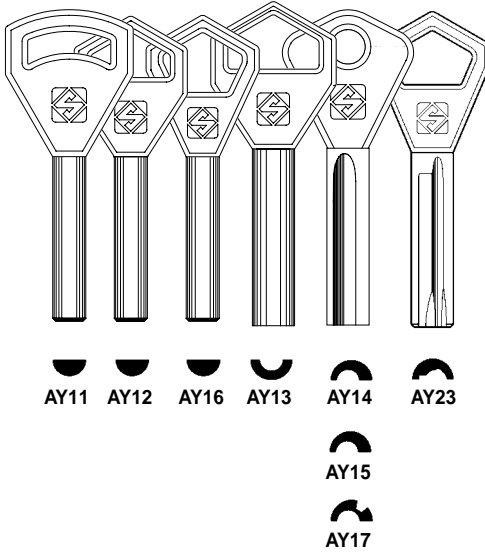

D705040ZB

Cutter 06 (HSS)
Fresa 06 (HSS)
Fräser 06 (HSS)
Fraise 06 (HSS)
Fresa 06 (HSS)



D706128ZB

Cutter 06W (metallo duro)
Fresa 06W (carbide)
Fräser 06W (Hartmetall)
Fraise 06W (au carbure)
Fresa 06W (metal duro)

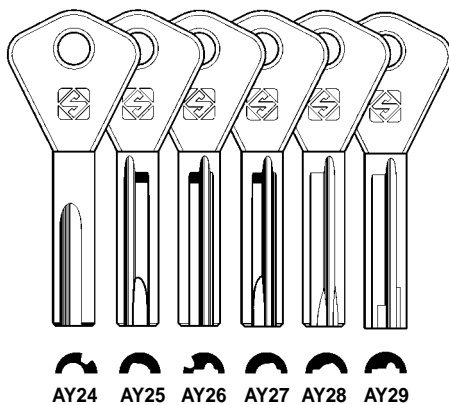

LANCER PLUS



PER:
FOR: **FORD (EU)**

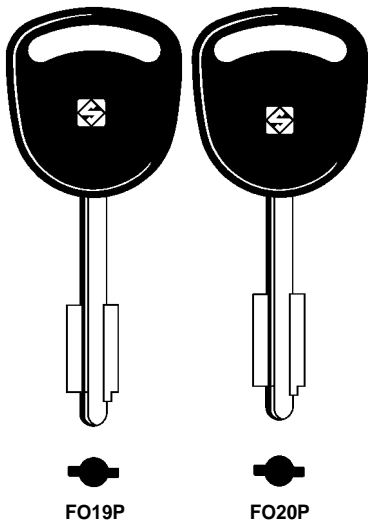

CHUBB (GB)

OPTIONAL

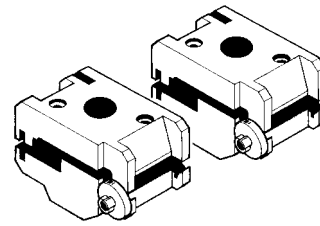

D703199ZB

*Special jaws
Coppia morsetti speciali
Sonderspannbacken
Étaux spéciaux
Mordazas especiales*

PER:
FOR: **FORD (EU + USA)**

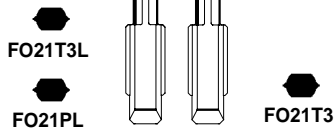
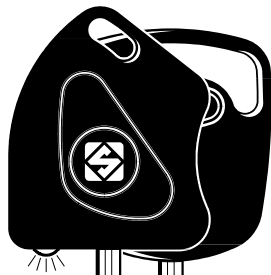

FO21P

FO21AP

IMPORTANT!

KEY BLANK TO BE APPLIED TO THE ORIGINAL REMOTE CONTROL
(THE REMOTE CONTROL INCLUDES THE TRANSPONDER CHIP)

TIBBE (D)
VALEO (F)

OPTIONAL

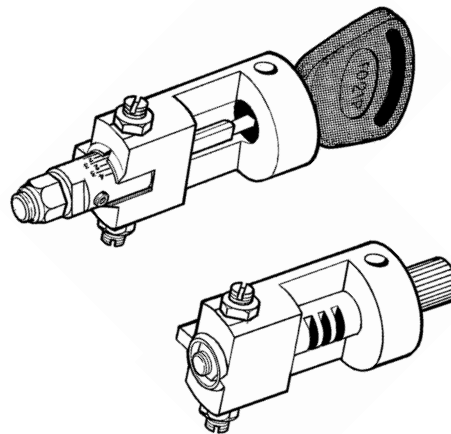

D705144ZB

*Code attachment
Dispositivo a codice
Code-Vorrichtung
Dispositif à code
Dispositivo a código*



LANCER PLUS



PER:
FOR:

AVA CHUBB (S)

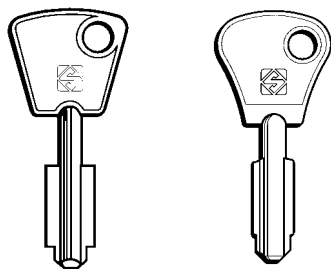

ACH

5ACH1

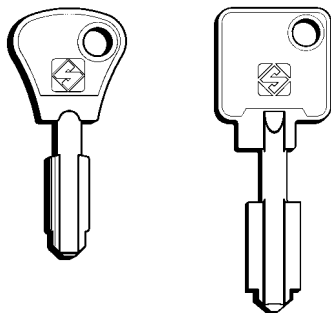

5ACH3

5ACH4

ANCHOR (S)

VALEO - SIMPLEX (F)

OPTIONAL



"A" side

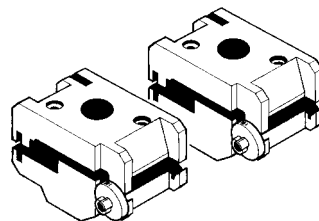

D703199ZB

*Special jaws
Coppia morsetti speciali
Sonderspannbacken
Étaux spéciaux
Mordazas especiales*

PER:
FOR:

CHUBB (GB)

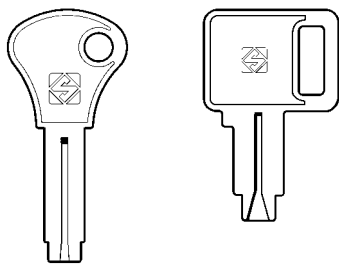

CHU7

CHU5

OPTIONAL



"B" side

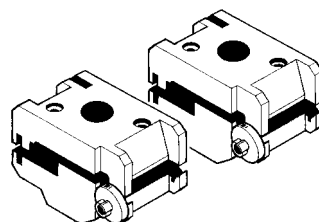

D703199ZB

*Special jaws
Coppia morsetti speciali
Sonderspannbacken
Étaux spéciaux
Mordazas especiales*



ATTENTION: for repairs or replacement of parts for maintenance, the 'CE' mark is guaranteed only if original spare parts provided by the manufacturer are used.

ATTENZIONE: in caso di riparazioni o sostituzione di pezzi per manutenzione, la marcatura "CE" è garantita solo se vengono utilizzate parti di ricambio originali fornite dal costruttore.

ACHTUNG: bei Reparaturen oder Auswechseln von Teilen zur Instandhaltung wird die CE-Markierung nur bei Verwendung von vom Hersteller gelieferten Originalersatzteilen gewährleistet.

ATTENTION: si vous effectuez des réparations ou que vous remplacez des pièces pendant un entretien, le marquage "CE" n'est garanti que si vous utilisez des pièces de rechange originales fournies par le fabricant.

ATENCIÓN: en caso de reparaciones o sustituciones de las piezas por mantenimiento, se garantiza la marca "CE" sólo si se utilizan partes de repuesto originales suministradas por el constructor.



SILCA S.p.A.

Via Podgora, 20 (Z.I.) 31029 VITTORIO VENETO (TV)

Tel. 0438 9136 Fax 0438 913800

www.silca.it

Member of the Kaba Group

