

TRIAX-E.CODE

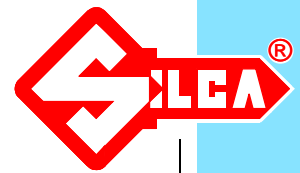

PER:
FOR:

AGB (I)

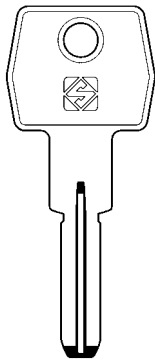

AGB5

OPTIONAL



D709117ZB

Cutter H106 (HSS)
Fresa H106 (HSS)
Fräser H106 (HSS)
Fraise H106 (HSS)
Fresa H106 (HSS)



D709243ZB

Cutter W106 (carbide)
Fresa W106 (metallo duro)
Fräser W106 (Hartmetall)
Fraise W106 (au carbure)
Fresa W106 (metal duro)

PER:
FOR:

AGB (I)

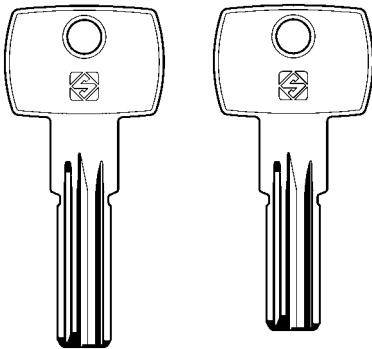

AGB6

AGB8

AGB7

AGB9

Scudo 5000

OPTIONAL



D709117ZB

Cutter H106 (HSS)
Fresa H106 (HSS)
Fräser H106 (HSS)
Fraise H106 (HSS)
Fresa H106 (HSS)



D709243ZB

Cutter W106 (carbide)
Fresa W106 (metallo duro)
Fräser W106 (Hartmetall)
Fraise W106 (au carbure)
Fresa W106 (metal duro)

PER:
FOR:

ASSA (S)

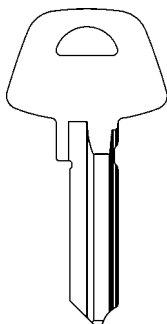

D-12

OPTIONAL



D736835ZB

Clamp R129
Morsetto R129
Spannbacken R129
Etau R129
Mordaza R129

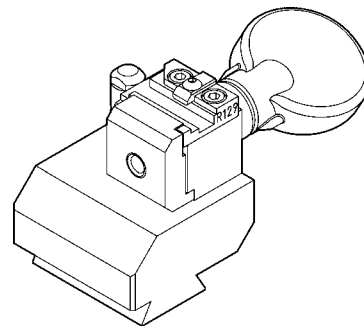

D735439ZB

Cutter W148
Fresa W148
Fräser W148
Fraise W148
Fresa W148

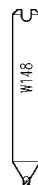

System protected by a password issued by Silca on receipt of authorization.
Sistema protetto da password rilasciata da Silca a fronte di autorizzazione.
System geschützt durch von Silca geliefertes Passwort auf Genehmigung.
Système protégé par un password qui est émis par Silca sur autorisation.
Sistema protegido por password que expide Silca contra autorización.



TRIAX-E.CODE

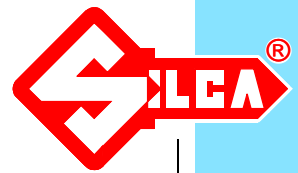

PER:
FOR:

ASSA (S)

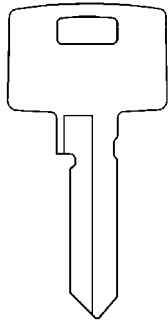

TWIN 6000

OPTIONAL



D735285ZB

Adapter A24 for Assa "Twin 6000" keys
Adattatore A24 per chiavi Assa "Twin 6000"
Adapter A24 für Assa "Twin 6000" Schlüssel
Adaptateur A24 pour clés Assa "Twin 6000"
Adaptador A24 para llaves Assa "Twin 6000"

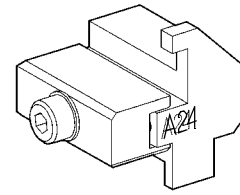

D709362ZB

Cutter W202 (carbide)
Fresa W202 (metallo duro)
Fräser W202 (Hartmetall)
Fraise W202 (au carbure)
Fresa W202 (metal duro)

PER:
FOR:

AZBE (E)

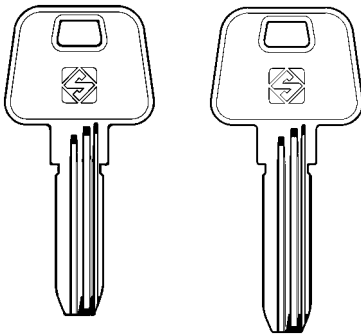

AZ6

AZ7

CAVERS (F)

OPTIONAL

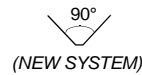

D709792ZB

Cutter W116 (carbide)
Fresa W116 (metallo duro)
Fräser W116 (Hartmetall)
Fraise W116 (au carbure)
Fresa W116 (metal duro)

PER:
FOR:

BKS (D)

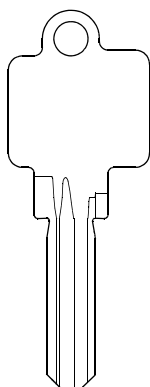

(WS50)

OPTIONAL

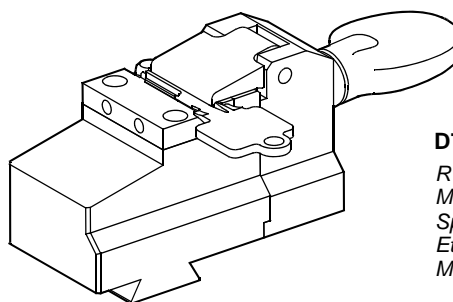

D727637ZB

R158 clamp
Morsetto R158
Spannbacke R158
Etau R158
Mordaza R158



D726008ZB

Cutter W273 (carbide)
Fresa W273 (metallo duro)
Fräser W273 (Hartmetall)
Fraise W273 (au carbure)
Fresa W273 (metal duro)



TRIAX-E.CODE

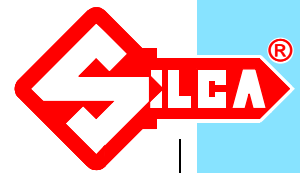

PER:
FOR:

BKS (D)

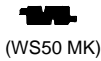
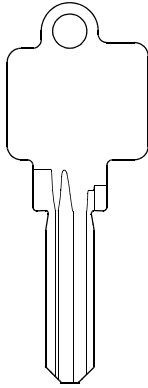

(WS50 MK)

OPTIONAL

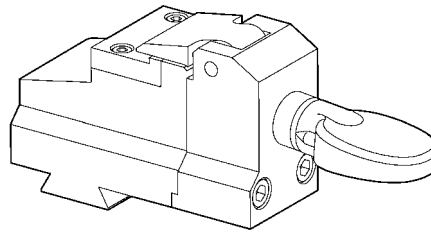

D729116ZB

R150 clamp
Morsetto R150
Spannbacke R150
Étau R150
Mordaza R150



D726008ZB

Cutter W273 (carbide)
Fresa W273 (metallo duro)
Fräser W273 (Hartmetall)
Fraise W273 (au carbure)
Fresa W273 (metal duro)

PER:
FOR:

CISA (I)

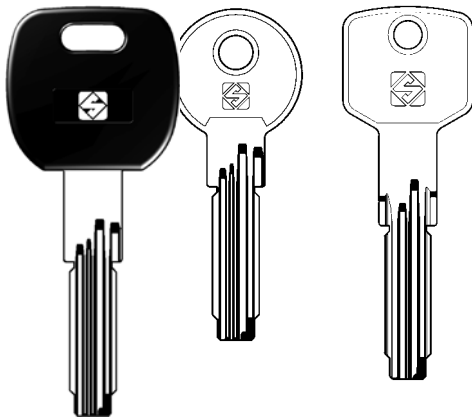

CS70P



CS70



CS62

ASTRAL
system 357



AB48

ABUS

OPTIONAL

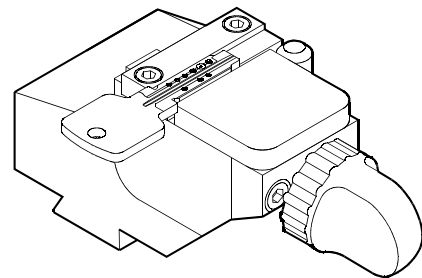

D720980ZB

R240 jaw
Morsetto R240
R240 Spannbacke
Étau R240
Mordaza R240

D708740ZB

Cutter H105 (HSS)
Fresa H105 (HSS)
Fräser H105 (HSS)
Fraise H105 (HSS)
Fresa H105 (HSS)



D709242ZB

Cutter W105 (carbide)
Fresa W105 (metallo duro)
Fräser W105 (Hartmetall)
Fraise W105 (au carbure)
Fresa W105 (metal duro)

ASTRAL system:

Codes tables protected by a password issued by Silca on receipt of the manufacturer's authorization.

Tabella codici protette da password rilasciata da Silca a fronte di autorizzazione del costruttore.

Code-Tabellen geschützt durch von Silca geliefertes Password auf Herstellersgenehmigung.

Tables de codes protégées par un password qui est émis par Silca sur autorisation du Constructeur.

Tablas codigos protegidos por password que expide Silca contra autorización del constructor.



TRIAX-E.CODE



PER:
FOR:

CISA (I)

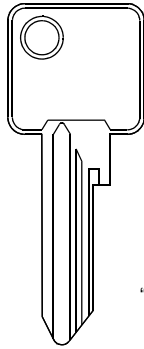

“SP” “TSP”
ABUS

OPTIONAL



D729323ZB

R149 clamp
Morsetto R149
Spannbacke R149
Étau R149
Mordaza R149



D728170ZB

Cutter W277 (carbide)
Fresa W277 (metallo duro)
Fräser W277 (Hartmetall)
Fraise W277 (au carbure)
Fresa W277 (metal duro)

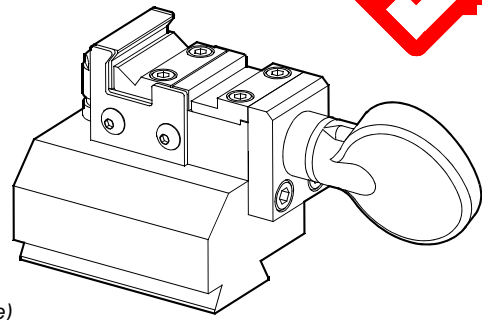

PER:
FOR:

CISA (II)

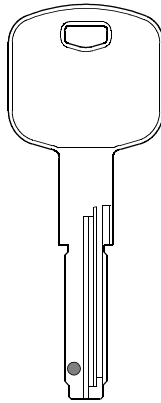

(AP3 System)

OPTIONAL

D724324ZB

Mobile jaw “B”
Ganascia mobile “B”
Backen “B”
Mâchoire mobile “B”
Quijada móvil “B”

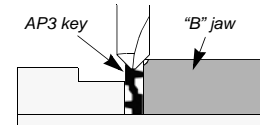
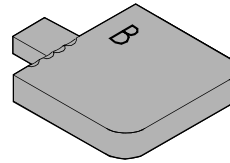

To fit on J240 and R240 clamps (before July 2002)
Da applicare ai morsetti J240 e R240 (prima di luglio 2002)
Auf J240 und R240 Spannbacken zu installieren (vor Juli 2002)
A installer sur les étaux J240 et R240 (avant Juillet 2002)
A instalarse en las mordazas J240 y R240 (antes de Julio 2002)

OPTIONAL



D720980ZB

“R240” clamp (including “B” jaw)
Morsetto “R240” (con ganascia “B”)
“R240” Spannbacke (mit “B” Backen)
Étau “R240” (avec mâchoire “B”)
Mordaza “R240” (con quijada “B”)

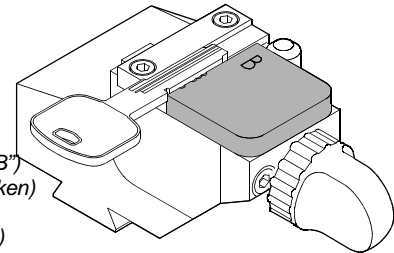

D708740ZB

Cutter H105 (HSS)
Fresa H105 (HSS)
Fräser H105 (HSS)
Fraise H105 (HSS)
Fresa H105 (HSS)



D709242ZB

Cutter W105 (carbide)
Fresa W105 (metallo duro)
Fräser W105 (Hartmetall)
Fraise W105 (au carbure)
Fresa W105 (metal duro)

System protected by a password issued by Silca on receipt of authorization.
Sistema protetto da password rilasciata da Silca a fronte di autorizzazione.
System geschützt durch von Silca geliefertes Passwort auf Genehmigung.
Système protégé par un password qui est émis par Silca sur autorisation.
Sistema protegido por password que expide Silca contra autorización.

PER:
FOR:

DOM (D)

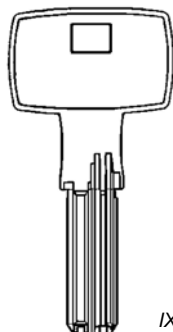

IXHT Profil 137

OPTIONAL



D733690ZB

R11 clamp
Morsetto R11
Spannbacke R11
Étau R11
Mordaza R11

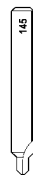

D729494ZB

Cutter W145 (carbide)
Fresa W145 (metallo duro)
Fräser W145 (Hartmetall)
Fraise W145 (au carbure)
Fresa W145 (metal duro)

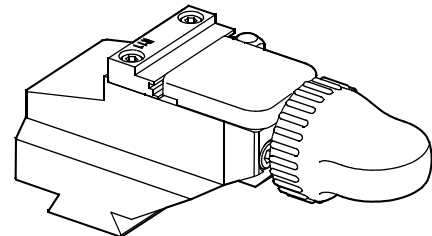

System protected by a password issued by Silca on receipt of authorization.
Sistema protetto da password rilasciata da Silca a fronte di autorizzazione.
System geschützt durch von Silca geliefertes Passwort auf Genehmigung.
Système protégé par un password qui est émis par Silca sur autorisation.
Sistema protegido por password que expide Silca contra autorización.



PER:
FOR:

DOM (D)

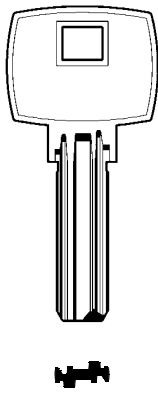

IX6 KG Profil 118

OPTIONAL



D722636ZB

R7 jaw
Morsetto R7
R7 Spannbacke
Étau R7
Mordaza R7

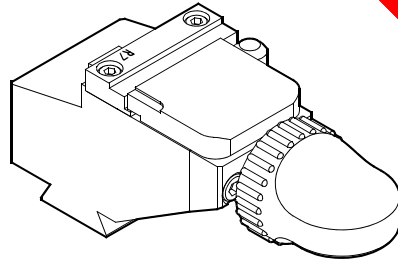

D721116ZB

Cutter W261 (carbide)
Fresa W261 (metallo duro)
Fräser W261 (Hartmetall)
Fraise W261 (au carbure)
Fresa W261 (metal duro)



D710569ZB

Cutter W124 (carbide)
Fresa W124 (metallo duro)
Fräser W124 (Hartmetall)
Fraise W124 (au carbure)
Fresa W124 (metal duro)

System protected by a password issued by Silca on receipt of authorization.
Sistema protetto da password rilasciata da Silca a fronte di autorizzazione.
System geschützt durch von Silca geliefertes Passwort auf Genehmigung.
Système protégé par un password qui est émis par Silca sur autorisation.
Sistema protegido por password que expide Silca contra autorización.

PER:
FOR:

DOM (D) CORBIN (I)

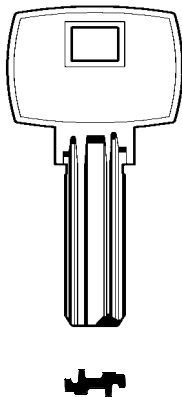

IX5 KG DAS Profile 101

OPTIONAL



D722636ZB

R7 jaw
Morsetto R7
R7 Spannbacke
Étau R7
Mordaza R7

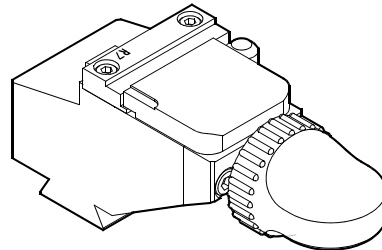

D710569ZB

Cutter W124 (carbide)
Fresa W124 (metallo duro)
Fräser W124 (Hartmetall)
Fraise W124 (au carbure)
Fresa W124 (metal duro)

System protected by a password issued by Silca on receipt of authorization.
Sistema protetto da password rilasciata da Silca a fronte di autorizzazione.
System geschützt durch von Silca geliefertes Passwort auf Genehmigung.
Système protégé par un password qui est émis par Silca sur autorisation.
Sistema protegido por password que expide Silca contra autorización.

PER:
FOR:

DOM (D) CORBIN (I)

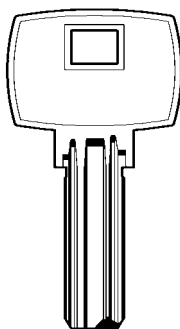

IX6 KG Profile 121

OPTIONAL



D721044ZB

R8 jaw
Morsetto R8
R8 Spannbacke
Étau R8
Mordaza R8

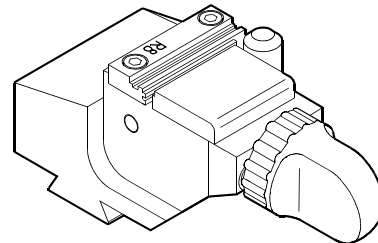

D710569ZB

Cutter W124 (carbide)
Fresa W124 (metallo duro)
Fräser W124 (Hartmetall)
Fraise W124 (au carbure)
Fresa W124 (metal duro)

System protected by a password issued by Silca on receipt of authorization.
Sistema protetto da password rilasciata da Silca a fronte di autorizzazione.
System geschützt durch von Silca geliefertes Passwort auf Genehmigung.
Système protégé par un password qui est émis par Silca sur autorisation.
Sistema protegido por password que expide Silca contra autorización.

PER:
FOR:

DOM (D)

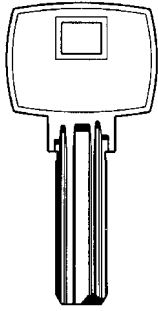

IX Gamma Profil

OPTIONAL



D738422ZB

Clamp R124
Morsetto R124
Spannbacken R124
Etau R124
Mordaza R124

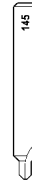
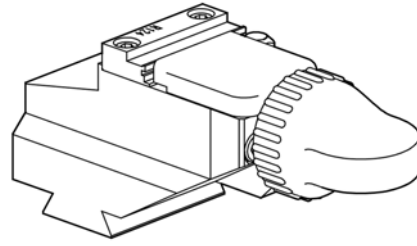

D729494ZB

Cutter W145 (carbide)
Fresa W145 (metallo duro)
Fräser W145 (Hartmetall)
Fraise W145 (au carbure)
Fresa W145 (metal duro)

System protected by a password issued by Silca on receipt of authorization.
Sistema protetto da password rilasciata da Silca a fronte di autorizzazione.
System geschützt durch von Silca geliefertes Password auf Genehmigung.
Système protégé par un password qui est émis par Silca sur autorisation.
Sistema protegido por password que expide Silca contra autorización.

PER:
FOR:

ELZETT (H)

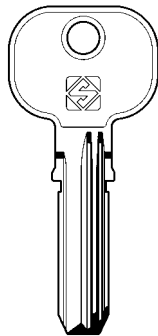

EL9

OPTIONAL



D708741ZB

Cutter H107 (HSS)
Fresa H107 (HSS)
Fräser H107 (HSS)
Fraise H107 (HSS)
Fresa H107 (HSS)



D709244ZB

Cutter W107 (carbide)
Fresa W107 (metallo duro)
Fräser W107 (Hartmetall)
Fraise W107 (au carbure)
Fresa W107 (metal duro)

PER:
FOR:

FIAM (I)

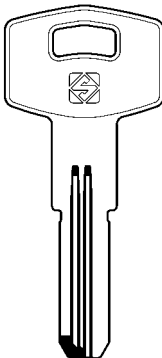

FI3R

OPTIONAL



D734309ZB

Adapter A20 for FIAM keys
Adattatore A20 per chiavi FIAM
Adapter A20 für FIAM Schlüssel
Adaptateur A20 pour clés FIAM
Adaptador A20 para llaves FIAM

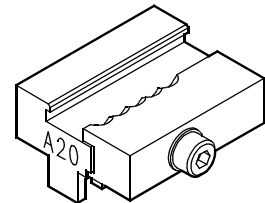

D709792ZB

Cutter W116 (carbide)
Fresa W116 (metallo duro)
Fräser W116 (Hartmetall)
Fraise W116 (au carbure)
Fresa W116 (metal duro)

TRIAX-E.CODE



PER:
FOR:

FICHET (F)

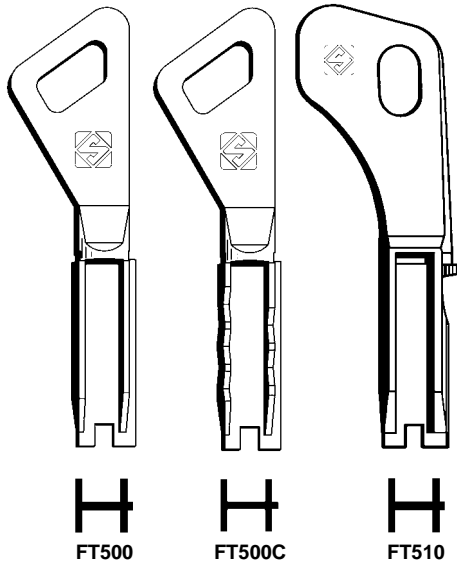

FT500

FT500C

FT510

OPTIONAL



D721084ZB

R6 jaw
Morsetto R6
R6 Spannbacke
Étau R6
Mordaza R6

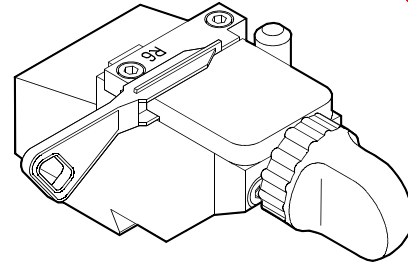

STANDARD

D708742ZB

Cutter H101 (HSS)
Fresa H101 (HSS)
Fräser H101 (HSS)
Fraise H101 (HSS)
Fresa H101 (HSS)



OPTIONAL

D709238ZB

Cutter W101 (carbide)
Fresa W101 (metallo duro)
Fräser W101 (Hartmetall)
Fraise W101 (au carbure)
Fresa W101 (metal duro)

PER:
FOR:

HUWIL (D)

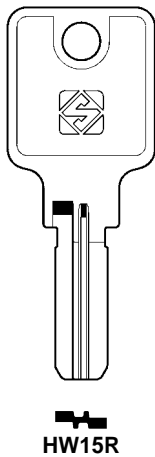

HW15R

OPTIONAL

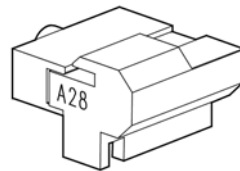

D736856ZB

Adapter A28 for HUWIL HW15R keys
Adattatore A28 per chiavi HUWIL HW15R
Adapter A28 für HUWIL HW15R Schlüssel
Adaptateur A28 pour clés HUWIL HW15R
Adaptador A28 para llaves HUWIL HW15R



D711604ZB

Cutter W129 (carbide)
Fresa W129 (metallo duro)
Fräser W129 (Hartmetall)
Fraise W129 (au carbure)
Fresa W129 (metal duro)

PER:
FOR:

ISEO (I)

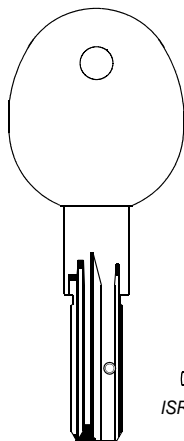

ISR100 WEB

OPTIONAL



D724187ZB

"R174" clamp
Morsetto "R174"
"R174" Spannbacke
Étau "R174"
Mordaza "R174"

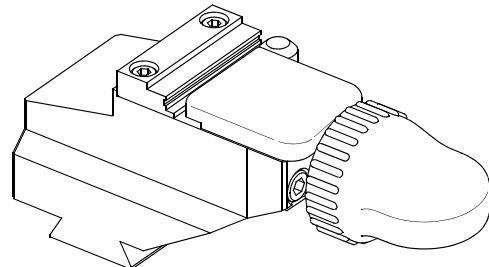

D709117ZB

Cutter H106 (HSS)
Fresa H106 (HSS)
Fräser H106 (HSS)
Fraise H106 (HSS)
Fresa H106 (HSS)



D709243ZB

Cutter W106 (carbide)
Fresa W106 (metallo duro)
Fräser W106 (Hartmetall)
Fraise W106 (au carbure)
Fresa W106 (metal duro)

System managed by the Manufacturer via Web connection.
Sistema gestito dal Costruttore tramite collegamento Web.
Das System wird vom Hersteller über Internet verwaltet.
Système géré par le Constructeur par connexion Web.
Sistema controlado por el Constructor por medio de conexión Web.



PER:
FOR:

KABA (CH)

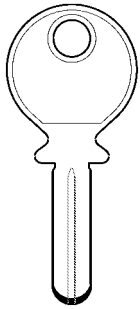

(KABA EXPERT)

OPTIONAL



D722937ZB

R4 tilting clamp
Morsetto basculante R4
Verstellbarer Spannbacken R4
Étau basculant R4
Mordaza basculante R4

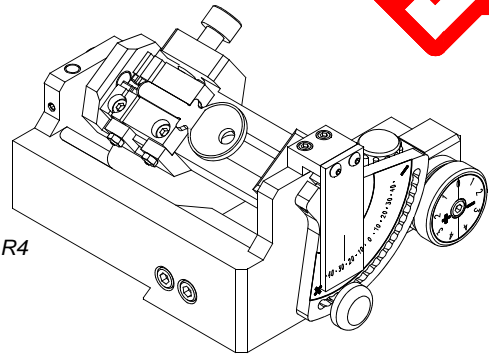

D908994ZR

Tracer point U102
Tastatore U102
Taster U102
Palpeur U102
Palpador U102



D721004ZB

Cutter W135 (carbide)
Fresa W135 (metallo duro)
Fräser W135 (Hartmetall)
Fraise W135 (au carbure)
Fresa W135 (metal duro)

System protected by a password issued by Silca on receipt of authorization.
Sistema protetto da password rilasciata da Silca a fronte di autorizzazione.
System geschützt durch von Silca geliefertes Passwort auf Genehmigung.
Système protégé par un password qui est émis par Silca sur autorisation.
Sistema protegido por password que expide Silca contra autorización.

PER:
FOR:

KABA (CH)

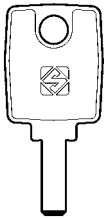

KA8

(KABA-MICRO)

OPTIONAL



D729845ZB

A18 adapter
Adattatore A18
Adapter A18
Adaptateur A18
Adaptador A18

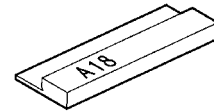

D908994ZR
Tracer point U102
Tastatore U102
Taster U102
Palpeur U102
Palpador U102

D710157ZB

Cutter H119 (HSS)
Fresa H119 (HSS)
Fräser H119 (HSS)
Fraise H119 (HSS)
Fresa H119 (HSS)



D710158ZB

Cutter W119 (carbide)
Fresa W119 (metallo duro)
Fräser W119 (Hartmetall)
Fraise W119 (au carbure)
Fresa W119 (metal duro)

PER:
FOR:

KYR (I)

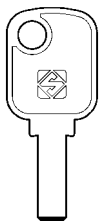

SCU1

SECURITAL

OPTIONAL



D729845ZB

A18 adapter
Adattatore A18
Adapter A18
Adaptateur A18
Adaptador A18

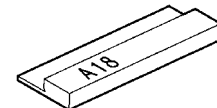

D908994ZR
Tracer point U102
Tastatore U102
Taster U102
Palpeur U102
Palpador U102

D709117ZB

Cutter H106 (HSS)
Fresa H106 (HSS)
Fräser H106 (HSS)
Fraise H106 (HSS)
Fresa H106 (HSS)



D709243ZB

Cutter W106 (carbide)
Fresa W106 (metallo duro)
Fräser W106 (Hartmetall)
Fraise W106 (au carbure)
Fresa W106 (metal duro)

PER:
FOR:

KESO (CH)

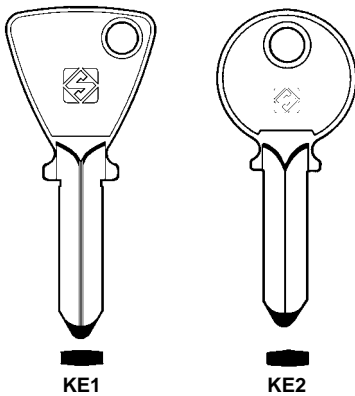

KE1

KE2

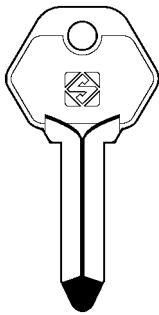

KE4

1000 System

OPTIONAL



D722937ZB

R4 tilting clamp
Morsetto basculante R4
Verstellbarer Spannbacken R4
Étau basculant R4
Mordaza basculante R4



D908994ZR

Tracer point U102
Tastatore U102
Taster U102
Palpeur U102
Palpador U102



D708741ZB

Cutter H107 (HSS)
Fresa H107 (HSS)
Fräser H107 (HSS)
Fraise H107 (HSS)
Fresa H107 (HSS)



D709244ZB

Cutter W107 (carbide)
Fresa W107 (metallo duro)
Fräser W107 (Hartmetall)
Fraise W107 (au carbure)
Fresa W107 (metal duro)

D710438ZB

Cutter W123 (carbide)
Fresa W123 (metallo duro)
Fräser W123 (Hartmetall)
Fraise W123 (au carbure)
Fresa W123 (metal duro)

1000 System

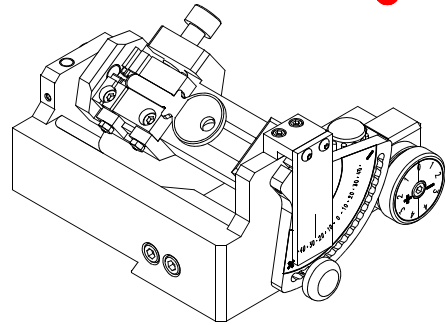

OPTIONAL



D722937ZB

R4 tilting clamp
Morsetto basculante R4
Verstellbarer Spannbacken R4
Étau basculant R4
Mordaza basculante R4



D908994ZR

Tracer point U102
Tastatore U102
Taster U102
Palpeur U102
Palpador U102



D709118ZB

Cutter H108 (HSS)
Fresa H108 (HSS)
Fräser H108 (HSS)
Fraise H108 (HSS)
Fresa H108 (HSS)



D709245ZB

Cutter W108 (carbide)
Fresa W108 (metallo duro)
Fräser W108 (Hartmetall)
Fraise W108 (au carbure)
Fresa W108 (metal duro)



D712737ZB

Cutter W132 (carbide)
Fresa W132 (metallo duro)
Fräser W132 (Hartmetall)
Fraise W132 (au carbure)
Fresa W132 (metal duro)



D710438ZB

Cutter W123 (carbide)
Fresa W123 (metallo duro)
Fräser W123 (Hartmetall)
Fraise W123 (au carbure)
Fresa W123 (metal duro)

1000S System

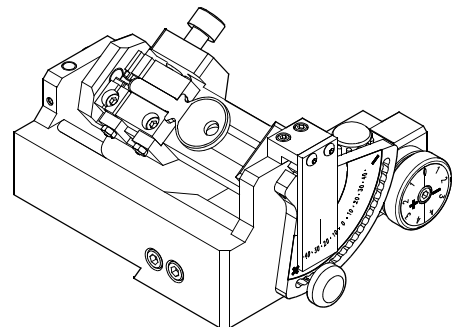

PER:
FOR:

KESO (CH)

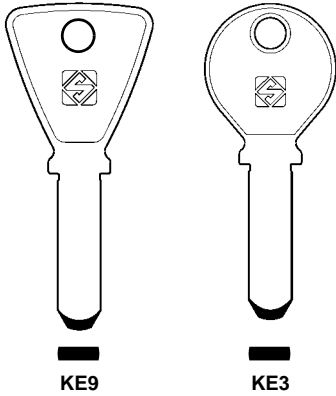

KE9

KE3

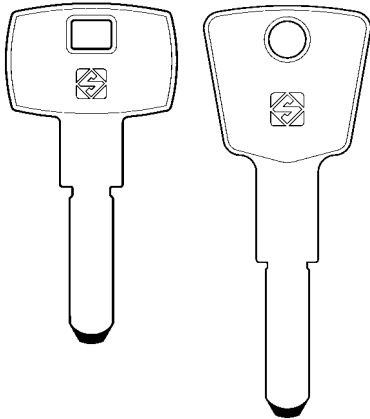

KE11

KE13

2000 System
2000S System

OPTIONAL



D708741ZB

Cutter H107 (HSS)
Fresa H107 (HSS)
Fräser H107 (HSS)
Fraise H107 (HSS)
Fresa H107 (HSS)



D709244ZB

Cutter W107 (carbide)
Fresa W107 (metallo duro)
Fräser W107 (Hartmetall)
Fraise W107 (au carbure)
Fresa W107 (metal duro)



D709118ZB

Cutter H108 (HSS)
Fresa H108 (HSS)
Fräser H108 (HSS)
Fraise H108 (HSS)
Fresa H108 (HSS)



D709245ZB

Cutter W108 (carbide)
Fresa W108 (metallo duro)
Fräser W108 (Hartmetall)
Fraise W108 (au carbure)
Fresa W108 (metal duro)

2000S System



D709118ZB

Cutter H108 (HSS)
Fresa H108 (HSS)
Fräser H108 (HSS)
Fraise H108 (HSS)
Fresa H108 (HSS)



D709245ZB

Cutter W108 (carbide)
Fresa W108 (metallo duro)
Fräser W108 (Hartmetall)
Fraise W108 (au carbure)
Fresa W108 (metal duro)



D712737ZB

Cutter W132 (carbide)
Fresa W132 (metallo duro)
Fräser W132 (Hartmetall)
Fraise W132 (au carbure)
Fresa W132 (metal duro)

PER:
FOR:

KESO (CH)

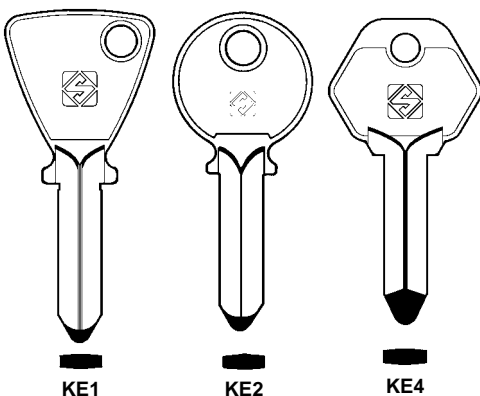

KE1

KE2

KE4

3000/S System

OPTIONAL



D722937ZB

R4 tilting clamp
Morsetto basculante R4
Verstellbarer Spannbacken R4
Étau basculant R4
Mordaza basculante R4

3000/S System

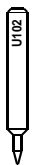
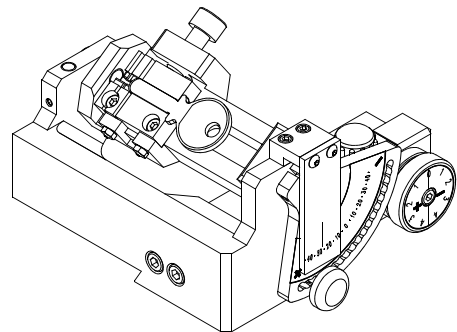

D908994ZR

Tracer point U102
Tastatore U102
Taster U102
Palpeur U102
Palpador U102



D710438ZB

Cutter W123 (carbide)
Fresa W123 (metallo duro)
Fräser W123 (Hartmetall)
Fraise W123 (au carbure)
Fresa W123 (metal duro)



D722178ZB

Cutter W136 (carbide)
Fresa W136 (metallo duro)
Fräser W136 (Hartmetall)
Fraise W136 (au carbure)
Fresa W136 (metal duro)

PER:
FOR:

LINCE (E)

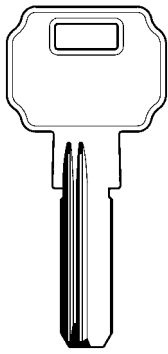

(XA, XB, ...)
(C3)

OPTIONAL



D726002ZB

Adapter for Lince keys
Adattatore per chiavi Lince
Adapter für Lince Schlüssel
Adaptateur pour clés Lince
Adaptador para llaves Lince

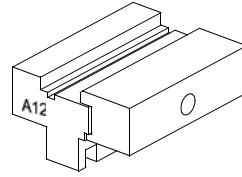

D908994ZR

Tracer point U102
Tastatore U102
Taster U102
Palpeur U102
Palpador U102

(XA, XB, ... system)

D708741ZB

Cutter H107 (HSS)
Fresa H107 (HSS)
Fräse H107 (HSS)
Fraise H107 (HSS)
Fresa H107 (HSS)



D709244ZB

Cutter W107 (carbide)
Fresa W107 (metallo duro)
Fräse W107 (Hartmetall)
Fraise W107 (au carbure)
Fresa W107 (metal duro)

(C3 system)



D709792ZB

Cutter W116 (carbide)
Fresa W116 (metallo duro)
Fräse W116 (Hartmetall)
Fraise W116 (au carbure)
Fresa W116 (metal duro)

PER:
FOR:

LINCE (E)

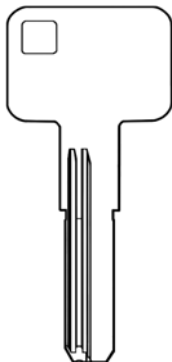

(C5X)

OPTIONAL



D737126ZB

Clamp R127
Morsetto R127
Spannbacken R127
Etau R127
Mordaza R127

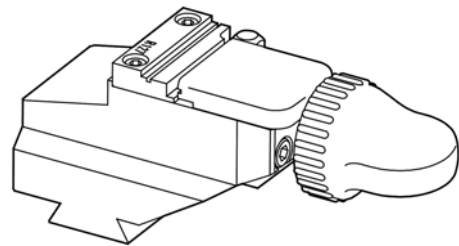

OPTIONAL

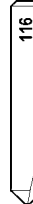
C5X Interp.	C5X
 <p>D737183ZB Cutter W301 (carbide) Fresa W301 (metallo duro) Fräser W301 (Hartmetall) Fraise W301 (au carbure) Fresa W301 (metal duro)</p>	 <p>D709792ZB Cutter W116 (carbide) Fresa W116 (metallo duro) Fräser W116 (Hartmetall) Fraise W116 (au carbure) Fresa W116 (metal duro)</p>

System protected by a password issued by Silca on receipt of authorization.
Sistema protetto da password rilasciata da Silca a fronte di autorizzazione.
System geschützt durch von Silca geliefertes Passwort auf Genehmigung.
Système protégé par un password qui est émis par Silca sur autorisation.
Sistema protegido por password que expide Silca contra autorización.

PER:
FOR:

LIPS (NL)

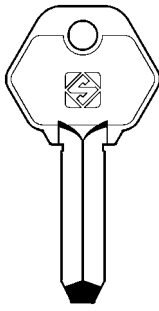

LP11

OPTIONAL



D722937ZB

R4 tilting clamp
Morsetto basculante R4
Verstellbarer Spannbacken R4
Étau basculant R4
Mordaza basculante R4

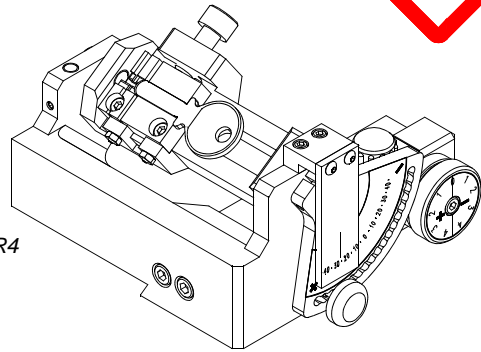

D908994ZR

Tracer point U102
Tastatore U102
Taster U102
Palpeur U102
Palpador U102

D708741ZB

Fresa H107 (HSS)
Cutter H107 (HSS)
Fräser H107 (HSS)
Fraise H107 (HSS)
Fresa H107 (HSS)



D709244ZB

Fresa W107 (metallo duro)
Cutter W107 (carbide)
Fräser W107 (Hartmetall)
Fraise W107 (au carbure)
Fresa W107 (metal duro)



D710438ZB

Fresa W123 (metallo duro)
Cutter W123 (carbide)
Fräser W123 (Hartmetall)
Fraise W123 (au carbure)
Fresa W123 (metal duro)



PER:
FOR:

MAGNUM (GB)

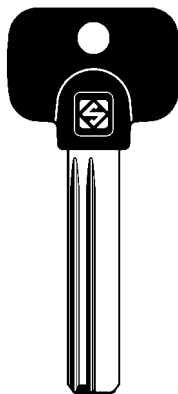

MGN1RP

Magnum Superior
(4+3+4P)

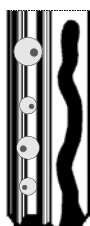

OPTIONAL



D722937ZB

Clamp R4
Morsetto R4
Spannbacken R4
Étau R4
Mordaza R4

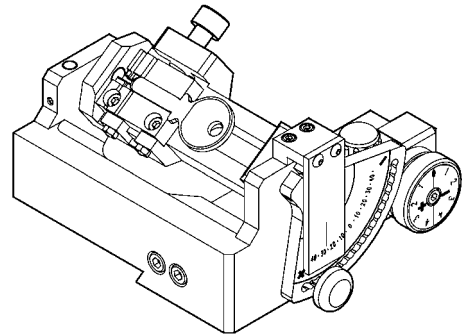

D908994ZR

Tracer point U102
Tastatore U102
Taster U102
Palpeur U102
Palpador U102



D728783ZB

Cutter W142 (carbide)
Fresa W142 (metallo duro)
Fräser W142 (Hartmetall)
Fraise W142 (au carbure)
Fresa W142 (metal duro)



D717483ZB

Cutter W268 (carbide)
Fresa W268 (metallo duro)
Fräser W268 (Hartmetall)
Fraise W268 (au carbure)
Fresa W268 (metal duro)

PER:
FOR:

MCM (E)

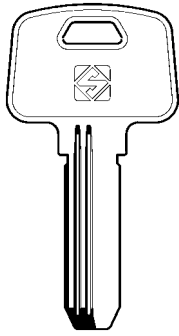



MC10R

OPTIONAL

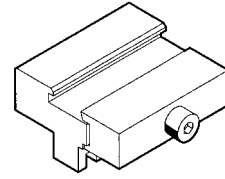

D711226ZB

Adaptor for MCM keys
Adattatore per chiavi MCM
Adapter für MCM Schlüssel
Adaptateur pour clés MCM
Adaptador para llaves MCM



D908994ZR

Tracer point U102
Tastatore U102
Taster U102
Palpeur U102
Palpador U102

D709123ZB

Cutter H113 (HSS)
Fresa H113 (HSS)
Fräser H113 (HSS)
Fraise H113 (HSS)
Fresa H113 (HSS)



D709250ZB

Cutter W113 (carbide)
Fresa W113 (metallo duro)
Fräser W113 (Hartmetall)
Fraise W113 (au carbure)
Fresa W113 (metal duro)

PER:
FOR:

MERONI (I)

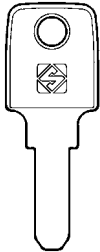



MER39

OPTIONAL

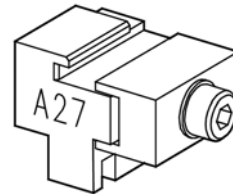

D736261B

Adapter A27 for Meroni keys
Adattatore A27 per chiavi Meroni
Adapter A27 für Meroni Schlüssel
Adaptateur A27 pour clés Meroni
Adaptador A27 para llaves Meroni



D709481ZB

Cutter H114 (HSS)
Fresa H114 (HSS)
Fräser H114 (HSS)
Fraise H114 (HSS)
Fresa H114 (HSS)



D709482ZB

Cutter W114 (carbide)
Fresa W114 (metallo duro)
Fräser W114 (Hartmetall)
Fraise W114 (au carbure)
Fresa W114 (metal duro)

PER:
FOR:

MG-MONTI (I)

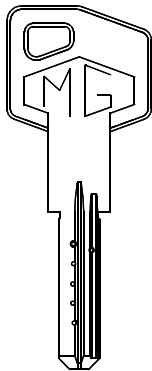

(HSP)

OPTIONAL

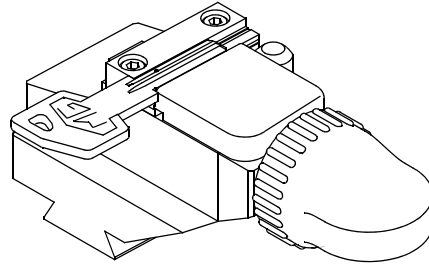

D724813ZB

R170 clamp
Morsetto R170
R170 Spannbacke
Étau R170
Mordaza R170

D709117ZB

Cutter H106 (HSS)
Fresa H106 (HSS)
Fräser H106 (HSS)
Fraise H106 (HSS)
Fresa H106 (HSS)



D709243ZB

Cutter W106 (carbide)
Fresa W106 (metallo duro)
Fräser W106 (Hartmetall)
Fraise W106 (au carbure)
Fresa W106 (metal duro)

System protected by a password issued by Silca on receipt of authorization.
Sistema protetto da password rilasciata da Silca a fronte di autorizzazione.
System geschützt durch von Silca geliefertes Passwort auf Genehmigung.
Système protégé par un password qui est émis par Silca sur autorisation.
Sistema protegido por password que expide Silca contra autorización.

PER:
FOR:

MOTTURA (I)

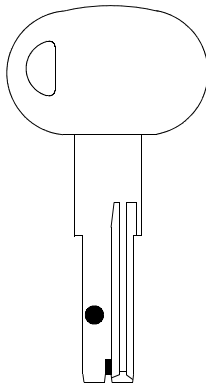

C30 C31 C38

Champions System

OPTIONAL



D722573ZB

Cutter H138 (HSS)
Fresa H138 (HSS)
Fräser H138 (HSS)
Fraise H138 (HSS)
Fresa H138 (HSS)



D722580ZB

Cutter W138 (carbide)
Fresa W138 (metallo duro)
Fräser W138 (Hartmetall)
Fraise W138 (au carbure)
Fresa W138 (metal duro)

D724358ZB

Pair of bars
Coppia barrette
Stahlstab
Couple de barrettes
Par de barritas

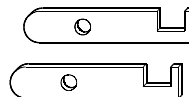

Only for C38 System
Solo per C38 System
Nur für C38 System
Seulement pour C38 System
Solo para C38 System

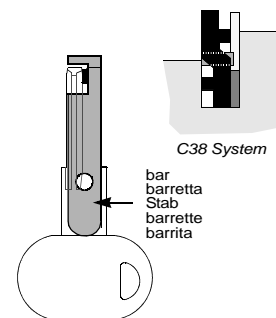

C38 System

bar
barretta
Stab
barrette
barrita

TRIAX-E.CODE



PER: MUL.T.LOCK (IL)
FOR:

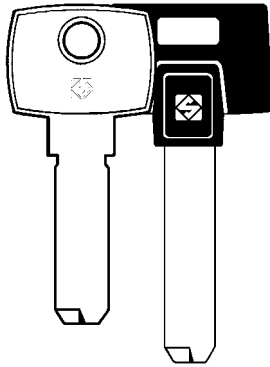

MTK1 MTK2P
MTK3P

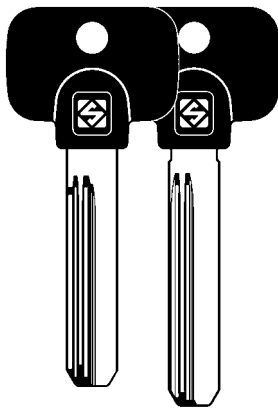

MTK10RP MTK4RPX

MTK4P MTK7RP

MTK4RP MTK8RP

OPTIONAL



D709120ZB

Cutter H110 (HSS)
Fresa H110 (HSS)
Fräser H110 (HSS)
Fraise H110 (HSS)
Fresa H110 (HSS)



D709247ZB

Cutter W110 (carbide)
Fresa W110 (metallo duro)
Fräser W110 (Hartmetall)
Fraise W110 (au carbure)
Fresa W110 (metal duro)



D709121ZB

Cutter H111 (HSS)
Fresa H111 (HSS)
Fräser H111 (HSS)
Fraise H111 (HSS)
Fresa H111 (HSS)



D709248ZB

Cutter W111 (carbide)
Fresa W111 (metallo duro)
Fräser W111 (Hartmetall)
Fraise W111 (au carbure)
Fresa W111 (metal duro)

PER: PFAFFENHAIN (D)
FOR:

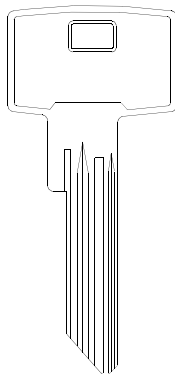

KV14
XV14

SN254

KV14

SN255

OPTIONAL



D727673ZB

Clamp R222
Morsetto R222
Spannbacken R222
Etau R222
Mordaza R222

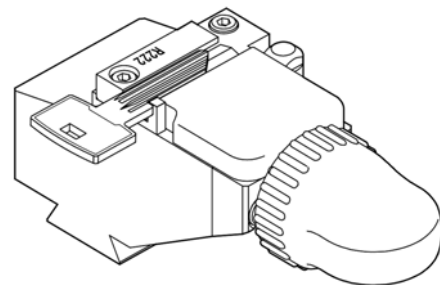

D734848ZB

Cutter W147(carbide)
Fresa W147 (metallo duro)
Fräser W147 (Hartmetall)
Fraise W147 (au carbure)
Fresa W147 (metal duro)



PER:
FOR:

POTENT (I)

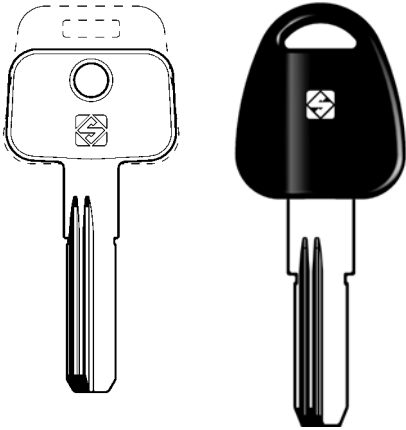

PT4R

PT5RP

OPTIONAL



D709116ZB

Fresa H104 (HSS)
Cutter H104 (HSS)
Fräser H104 (HSS)
Fraise H104 (HSS)
Fresa H104 (HSS)



D709241ZB

Fresa W104 (metallo duro)
Cutter W104 (carbide)
Fräser W104 (Hartmetall)
Fraise W104 (au carbure)
Fresa W104 (metal duro)

OPTIONAL



Only for PT5RP
Solo per PT5RP
Nur für PT5RP
Seulement pour PT5RP
Sólo para PT5RP

D710026ZB

Adapter
Adattatore
Adapter
Adaptateur
Adaptador

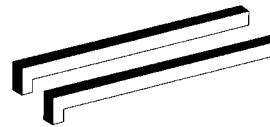

PER:
FOR:

SECUREMME (I)

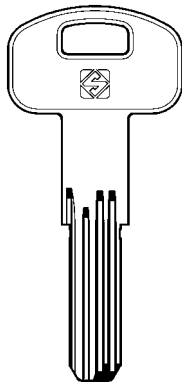

SCM2

OPTIONAL



D734531ZB

Adapter A21 for SECUREMME keys
Adattatore A21 per chiavi SECUREMME
Adapter A21 für SECUREMME Schlüssel
Adaptateur A21 pour clés SECUREMME
Adaptador A21 para llaves SECUREMME

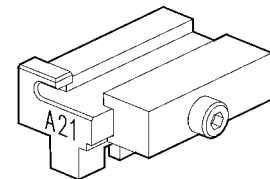

D908994ZR

Tracer point U102
Tastatore U102
Taster U102
Palpeur U102
Palpador U102



D709116ZB

Cutter H104 (HSS)
Fresa H104 (HSS)
Fräser H104 (HSS)
Fraise H104 (HSS)
Fresa H104 (HSS)



D709241ZB

Cutter W104 (carbide)
Fresa W104 (metallo duro)
Fräser W104 (Hartmetall)
Fraise W104 (au carbure)
Fresa W104 (metal duro)

PER:
FOR:

STS (E)
YALE (GB)

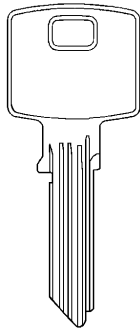



(9+9 pin)

OPTIONAL

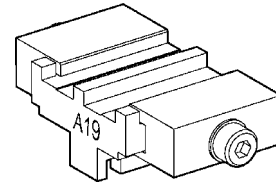

D730648ZB

Adapter A19 for YALE keys
Adattatore A19 per chiavi YALE
Adapter A19 für YALE Schlüssel
Adaptateur A19 pour clés YALE
Adaptador A19 para llaves YALE



D908994ZR

Tracer point U102
Tastatore U102
Taster U102
Palpeur U102
Palpador U102



D709792ZB

Cutter W116 (carbide)
Fresa W116 (metallo duro)
Fräser W116 (Hartmetall)
Fraise W116 (au carbure)
Fresa W116 (metal duro)

PER:
FOR:

STS (E)

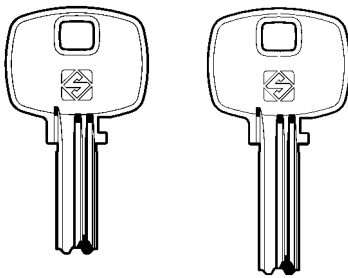

STS5



STS6

OPTIONAL

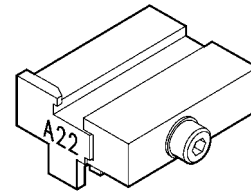

D734665ZB

Adapter A22 for STS keys
Adattatore A22 per chiavi STS
Adapter A22 für STS Schlüssel
Adaptateur A22 pour clés STS
Adaptador A22 para llaves STS



D908994ZR

Tracer point U102
Tastatore U102
Taster U102
Palpeur U102
Palpador U102



D709116ZB

Cutter H104 (HSS)
Fresa H104 (HSS)
Fräser H104 (HSS)
Fraise H104 (HSS)
Fresa H104 (HSS)



D709241ZB

Cutter W104 (carbide)
Fresa W104 (metallo duro)
Fräser W104 (Hartmetall)
Fraise W104 (au carbure)
Fresa W104 (metal duro)

TRIAX-E.CODE

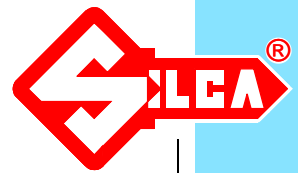

PER:
FOR:

TESA (E)

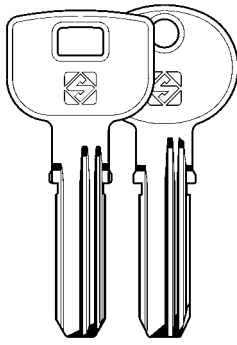

+ Original

OPTIONAL



D729938ZB

R179 clamp
MorsettofunR179
R179 Spannbacke
Étau R179
Mordaza R179

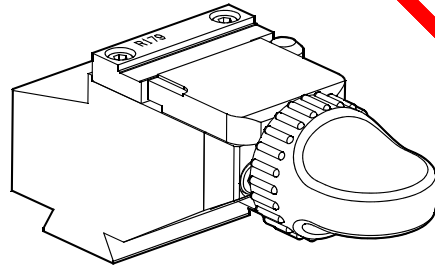

D714285ZB

Cutter W238 (carbide)
Fresa W238 (metal duro)
Fräser W238 (Hartmetall)
Fraise W238 (au carbure)
Fresa W238 (metal duro)

SN204 excluded
Escluso: SN204
Ausser: SN204
Exclu: SN204
SN204 no incluido



D711542ZB

Cutter W213 (carbide)
Fresa W213 (metal duro)
Fräser W213 (Hartmetall)
Fraise W213 (au carbure)
Fresa W213 (metal duro)

Only for: SN204
Solo per: SN204
Nur für: SN204
Seulement pour: SN204
Sólo para: SN204

Some systems are protected by a password issued by Silca at receipt of authorization.
Alcuni Sistemi sono protetti da Password rilasciata da Silca a fronte di autorizzazione.
Einige Systeme werden von das Silca auf Genehmigung geliefertes Passwort geschützt.
Certains systèmes sont protégés par un Password qui est émis par Silca sur autorisation.
Algunos sistemas son protegidos por Password que expide Silca bajo autorización.

PER:
FOR:

TESA (E)

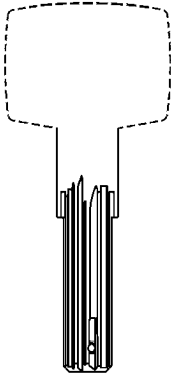

W293
(ST15)

OPTIONAL



D734541ZB

Clamp R137
Morsetto R137
Spannbacke R137
Étau R137
Mordaza R137

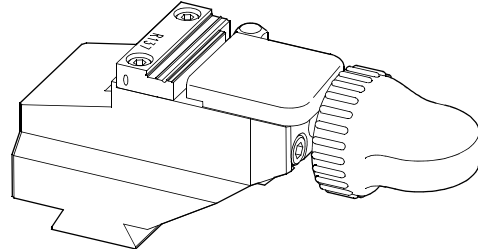

D734544ZB

Cutter W293 (carbide)
Fresa W293 (metal duro)
Fräser W293 (Hartmetall)
Fraise W293 (au carbure)
Fresa W293 (metal duro)

System protected by a password issued by Silca on receipt of authorization.
Sistema protetto da password rilasciata da Silca a fronte di autorizzazione.
System geschützt durch von Silca geliefertes Passwort auf Genehmigung.
Système protégé par un password qui est émis par Silca sur autorisation.
Sistema protegido por password que expide Silca contra autorización.



PER:
FOR:

VACHETTE (F)

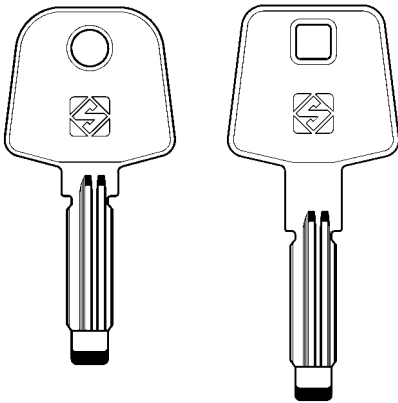

VAC91

VAC104

VAC103

VAC105

"VACHETTE RADIAL"

OPTIONAL



D722937ZB

R4 tilting clamp
Morsetto basculante R4
Verstellbarer Spannbacken R4
Étau basculant R4
Mordaza basculante R4

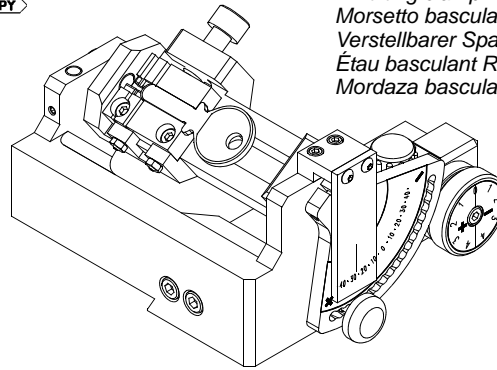

D908994ZR

Tracer point U102
Tastatore U102
Taster U102
Palpeur U102
Palpador U102

D709118ZB

Fresa H108 (HSS)
Cutter H108 (HSS)
Fräser H108 (HSS)
Fraise H108 (HSS)
Fresa H108 (HSS)



D709245ZB

Fresa W108 (metallo duro)
Cutter W108 (carbide)
Fräser W108 (Hartmetall)
Fraise W108 (au carbure)
Fresa W108 (metal duro)

PER:
FOR:

VIRO (I)

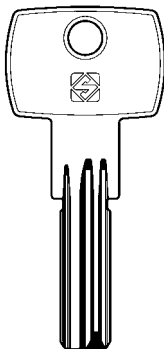

V119

OPTIONAL



D709116ZB

Fresa H104 (HSS)
Cutter H104 (HSS)
Fräser H104 (HSS)
Fraise H104 (HSS)
Fresa H104 (HSS)



D709241ZB

Fresa W104 (metallo duro)
Cutter W104 (carbide)
Fräser W104 (Hartmetall)
Fraise W104 (au carbure)
Fresa W104 (metal duro)

PER:
FOR:

WILKA (D)

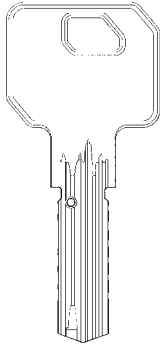

OPTIONAL



D735915ZB

Adapter A23 for Wilka 3VE keys
Adattatore A23 per chiavi Wilka 3VE
Adapter A23 für Wilka 3VE Schlüssel
Adaptateur A23 pour clés Wilka 3VE
Adaptador A23 para llaves Wilka 3VE

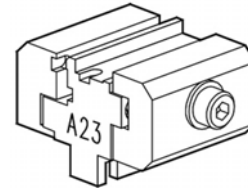

D735973ZB

Cutter W296 (carbide)
Fresa W296 (metallo duro)
Fräser W296 (Hartmetall)
Fraise W296 (au carbure)
Fresa W296 (metal duro)

OPTIONAL



D736166ZB

Tracer point U112 (carbide)
Tastatore U112 (metallo duro)
Taster U112 (Hartmetall)
Palpeur U112 (au carbure)
Palpador U112 (metal duro)

PER:
FOR:

WILKA (D)

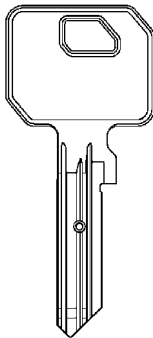

OPTIONAL



D735951ZB

Adapter A26 for Wilka TH6 keys
Adattatore A26 per chiavi Wilka TH6
Adapter A26 für Wilka TH6 Schlüssel
Adaptateur A26 pour clés Wilka TH6
Adaptador A26 para llaves Wilka TH6

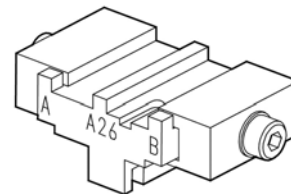

D735955ZB

Cutter W297 (carbide)
Fresa W297 (metallo duro)
Fräser W297 (Hartmetall)
Fraise W297 (au carbure)
Fresa W297 (metal duro)

OPTIONAL

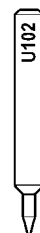

D908994ZR

Tracer point U102 (carbide)
Tastatore U102 (metallo duro)
Taster U102 (Hartmetall)
Palpeur U102 (au carbure)
Palpador U102 (metal duro)

PER: **WINKHAUS (D)**
FOR:

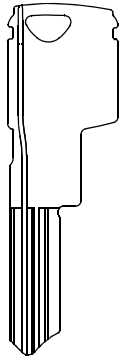

RPE - RPS

OPTIONAL



CARD 3364
SN 1323

D740054ZB

Clamp R114
Morsetto R114
Spannbacken R114
Étau R114
Mordaza R114

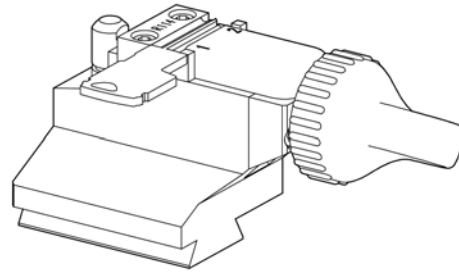

D714986ZB

Cutter W233 (carbide)
Fresa W233 (metallo duro)
Fräser W233 (Hartmetall)
Fraise W233 (au carbure)
Fresa W233 (metal duro)

System protected by a password issued by Silca on receipt of authorization.
Sistema protetto da password rilasciata da Silca a fronte di autorizzazione.
System geschützt durch von Silca geliefertes Passwort auf Genehmigung.
Système protégé par un password qui est émis par Silca sur autorisation.
Sistema protegido por password que expide Silca contra autorización.

PER: **WINKHAUS (D)**
FOR:

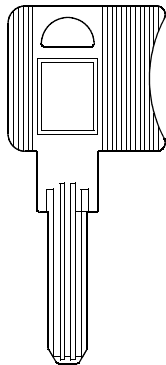

X-TRA

OPTIONAL



D721554ZB

R188 jaw
Morsetto R188
R188 Spannbacke
Étau R188
Mordaza R188

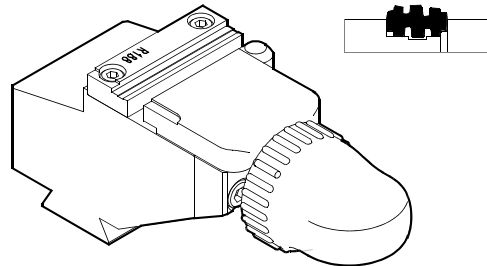

D717065ZB

Cutter W255 (carbide)
Fresa W255 (metallo duro)
Fräser W255 (Hartmetall)
Fraise W255 (au carbure)
Fresa W255 (metal duro)

System protected by a password issued by Silca on receipt of authorization.
Sistema protetto da password rilasciata da Silca a fronte di autorizzazione.
System geschützt durch von Silca geliefertes Passwort auf Genehmigung.
Système protégé par un password qui est émis par Silca sur autorisation.
Sistema protegido por password que expide Silca contra autorización.

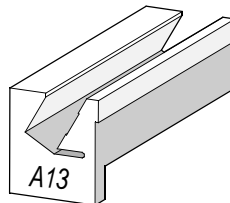

D726287ZB

A13 adaptor
Adattatore A13
A13 Adapter
Adaptateur A13
Adaptador A13

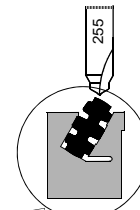

To fit on R188 clamp
Da applicare al morsetto R188
Die auf R188 Spannbacken zu installieren
À installer sur l'étau R188
A instalarse en la mordaza R188

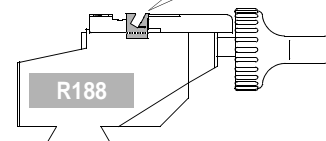

D717065ZB

Cutter W255 (carbide)
Fresa W255 (metallo duro)
Fräser W255 (Hartmetall)
Fraise W255 (au carbure)
Fresa W255 (metal duro)

System protected by a password issued by Silca on receipt of authorization.
Sistema protetto da password rilasciata da Silca a fronte di autorizzazione.
System geschützt durch von Silca geliefertes Passwort auf Genehmigung.
Système protégé par un password qui est émis par Silca sur autorisation.
Sistema protegido por password que expide Silca contra autorización.

PER:
FOR: **WINKHAUS (D)**

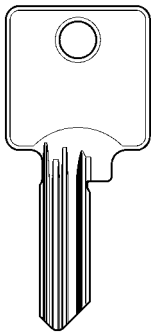

(Kalotten System)
(VS + VS6)

TOK-WINKHAUS

OPTIONAL



D721118ZB

R3 jaw
Morsetto R3
R3 Spannbacke
Étau R3
Mordaza R3

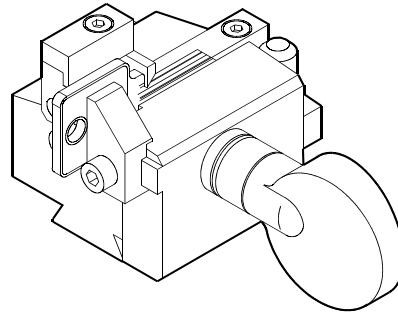

D709974ZB

Cutter H117 (HSS)
Fresa H117 (HSS)
Fräser H117 (HSS)
Fraise H117 (HSS)
Fresa H117 (HSS)



D710042ZB

Cutter W117 (carbide)
Fresa W117 (metallo duro)
Fräser W117 (Hartmetall)
Fraise W117 (au carbure)
Fresa W117 (metal duro)

PER:
FOR:

ZADI (I)

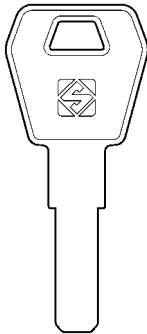

ZD25

OPTIONAL



D709481ZB

Cutter H114 (HSS)
Fresa H114 (HSS)
Fräser H114 (HSS)
Fraise H114 (HSS)
Fresa H114 (HSS)

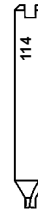

D709482ZB

Cutter W114 (carbide)
Fresa W114 (metallo duro)
Fräser W114 (Hartmetall)
Fraise W114 (au carbure)
Fresa W114 (metal duro)

PER:
FOR:

ZEISS IKON (D)

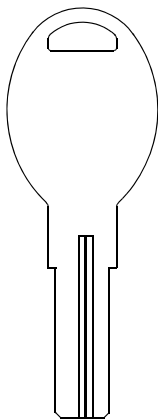

WSW

(2T-5W)

OPTIONAL



D726620ZB

A14 adaptor for ZEISS IKON Keys
Adattatore A14 per chiavi ZEISS IKON
A14 Adapter für ZEISS IKON Schlüssel
Adaptateur A14 pour clés ZEISS IKON
Adaptador A14 para llaves ZEISS IKON

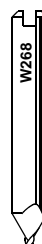
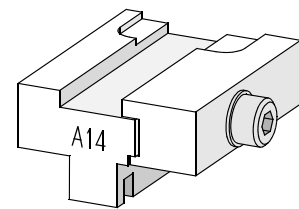

D717483ZB

Cutter W268 (carbide)
Fresa W268 (metallo duro)
Fräse W268 (Hartmetall)
Fraise W268 (au carbure)
Fresa W268 (metal duro)

PER:
FOR:

AUDI (D)
FORD (D)
PORSCHE (D)
SEAT (E)
SKODA (CZ)
VOLKSWAGEN (D)

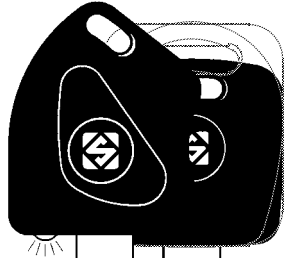

HU66PL
HU66T5L

HU66BT1

HU66T1 **HU66AT6**
HU66T5 **HU66T10**
HU66T6 **HU66T15**
HU66AT5 **HU66BT15**

HU66CT5
HU66DT5
HU66CT6

HU75T

HUF (D) - WITTE (D)

OPTIONAL



D720759ZB

R5 jaw
Morsetto R5
R5 Spannbacke
Étau R5
Mordaza R5

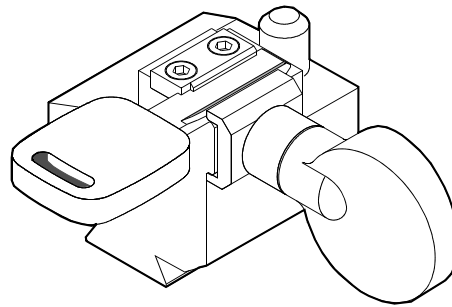

D711604ZB

Cutter W129 (carbide)
Fresa W129 (metallo duro)
Fräser W129 (Hartmetall)
Fraise W129 (au carbure)
Fresa W129 (metal duro)

PER:
FOR:

BMW (D)

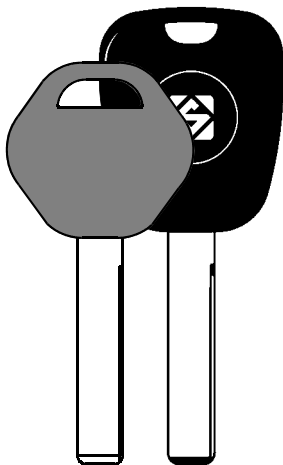

HU92RP

Valet Key for BMW, without transponder
Chiave di servizio per BMW, senza transponder
Serviceschlüssel für BMW, ohne transponder
Clé de service pour BMW, sans transpondeur
Llave de servicio para BMW, sin Transponder

OPTIONAL



D726239ZB

R162 jaw
Morsetto R162
R162 Spannbacken
Étau R162
Mordaza R162

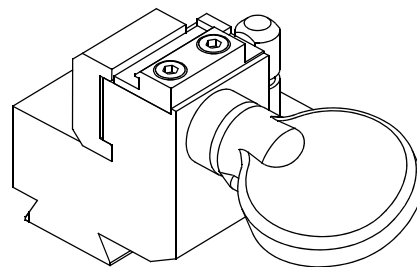

D711604ZB

Cutter W129 (carbide)
Fresa W129 (metallo duro)
Fräse W129 (Hartmetall)
Fraise W129 (au carbure)
Fresa W129 (metal duro)

TRIAX-E.CODE

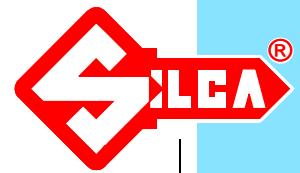

PER:
FOR: **FORD (EU+USA)**

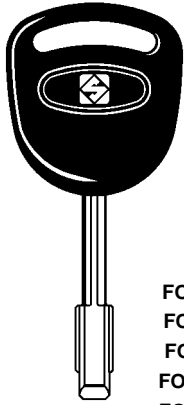

FO21AP
FO21PL
FO21T3
FO21T3L
FO21T17
FO21T7
FO21P
FO21T3M

OPTIONAL

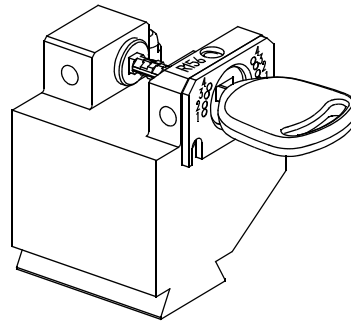

D727875ZB
R156 clamp
Morsetto R156
Spannbacke R156
Etau R156
Mordaza R156

STANDARD
D708742ZB

Cutter H101 (HSS)
Fresa H101 (HSS)
Fräser H101 (HSS)
Fraise H101 (HSS)
Fresa H101 (HSS)

OPTIONAL
D709238ZB

Cutter W101 (carbide)
Fresa W101 (metallo duro)
Fräser W101 (Hartmetall)
Fraise W101 (au carbure)
Fresa W101 (metal duro)



PER:
FOR: **HONDA (J)**



HON66T5
HON66T6
HON66T14
HOV01T5

HON66GP

OPTIONAL



STANDARD
D708742ZB

Cutter H101 (HSS)
Fresa H101 (HSS)
Fräser H101 (HSS)
Fraise H101 (HSS)
Fresa H101 (HSS)

OPTIONAL
D709238ZB

Cutter W101 (carbide)
Fresa W101 (metallo duro)
Fräser W101 (Hartmetall)
Fraise W101 (au carbure)
Fresa W101 (metal duro)



PER:
FOR: **HUF (D)**

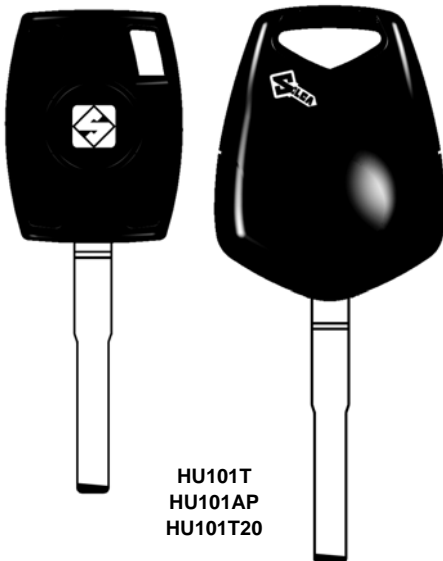

HU101T
HU101AP
HU101T20

HU101T17

HU101EH

OPTIONAL



D726440ZB
R160 clamp
Morsetto R160
Spannbacke R160
Etau R160
Mordaza R160

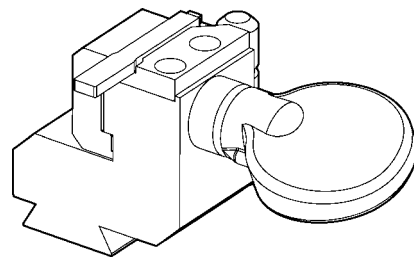

D711604ZB

Cutter W129 (carbide)
Fresa W129 (metallo duro)
Fräser W129 (Hartmetall)
Fraise W129 (au carbure)
Fresa W129 (metal duro)



TRIAX-E.CODE

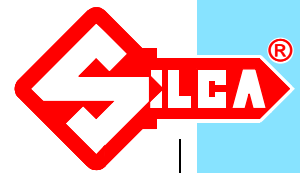

PER:
FOR:

TOYOTA (J)



TOY48P
TOY48BT4

ARISTO

OPTIONAL



D711108ZB

Tracer point U103
Tastatore U103
Taster U103
Palpeur U103
Palpador U103



STANDARD

D708742ZB

Cutter H101 (HSS)
Fresa H101 (HSS)
Fräser H101 (HSS)
Fraise H101 (HSS)
Fresa H101 (HSS)



OPTIONAL

D709238ZB

Cutter W101 (carbide)
Fresa W101 (metallo duro)
Fräser W101 (Hartmetall)
Fraise W101 (au carbure)
Fresa W101 (metal duro)

PER:
FOR:

CHICAGO (USA)

CH9T

MERONI (I)

MER22T
MER25T

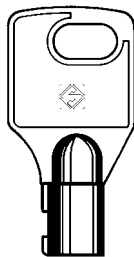
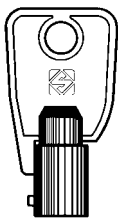

CH9T



MER22T

OPTIONAL



D720965ZB

R9 jaw
Morsetto R9
R9 Spannbacke
Étau R9
Mordaza R9

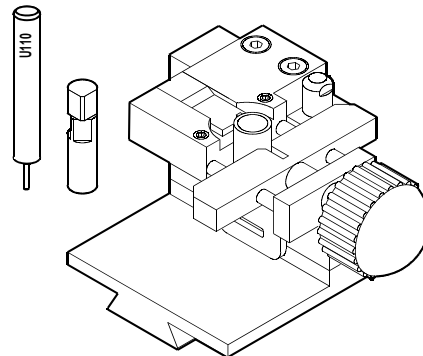

D712438ZB

Cutter H131 (HSS)
Fresa H131 (HSS)
Fräser H131 (HSS)
Fraise H131 (HSS)
Fresa H131 (HSS)



D712633ZB

Cutter W131 (carbide)
Fresa W131 (metallo duro)
Fräser W131 (Hartmetall)
Fraise W131 (au carbure)
Fresa W131 (metal duro)



PER:
FOR:

KENSTAN (USA)

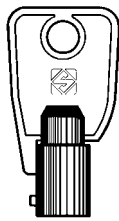

CH9T

OPTIONAL



D711604ZB

Cutter W129 (carbide)
Fresa W129 (metallo duro)
Fräser W129 (Hartmetall)
Fraise W129 (au carbure)
Fresa W129 (metal duro)

D720965ZB

R9 jaw
Morsetto R9
R9 Spannbacke
Étau R9
Mordaza R9

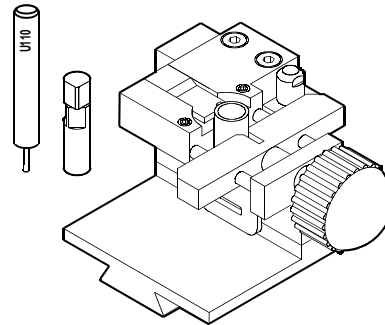

PER:
FOR:

TUBULAR KEYS
CHIAVI TUBOLARI
STECKSCHLÜSSEL
CLÉS TUBULAIRES
LLAVES TUBOLARES

7 - 10 pin

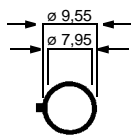
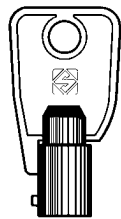

CH9T

OPTIONAL

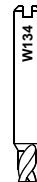

D723062ZB

Cutter W134 (carbide)
Fresa W134 (metallo duro)
Fräser W134 (Hartmetall)
Fraise W134 (au carbure)
Fresa W134 (metal duro)

D720965ZB

R9 jaw
Morsetto R9
R9 Spannbacke
Étau R9
Mordaza R9

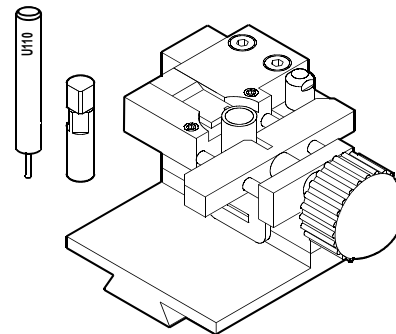

OPTIONAL

Swarf vacuum device

D717851ZB (230V-50Hz)
D718348ZB (100/110V-60Hz)

Swarf vacuum device
Dispositivo di aspirazione trucioli
Späneabsaugvorrichtung
Dispositif d'aspiration des rognures
Dispositivo aspirador de virutas

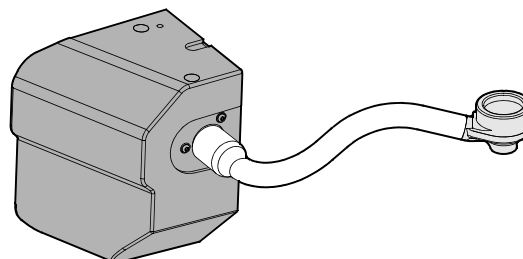

ENGRAVING

OPTIONAL
TRIAX-E.CODE

D733984ZB

R12 clamp
Morsetto R12
Spannbacken R12
Étau R12
Mordaza R12

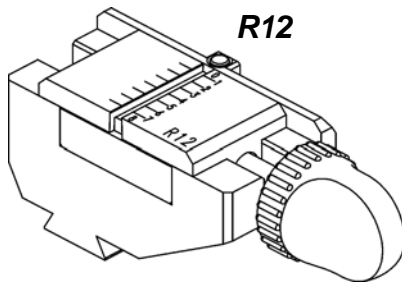

R12

Single clamp: ENGRAVING FUNCTION
Morsetto singolo: FUNZIONE INCISIONE
Einzelspannbacke: GRAVURFUNKTION
Etau à une position: FONCTION DE GRAVURE
Mordaza individual: GRABADO

D734267ZB

Cutter W146 (carbide)
Fresa W146 (metallo duro)
Fräser W146 (Hartmetall)
Fraise W146 (au carbure)
Fresa W146 (metal duro)

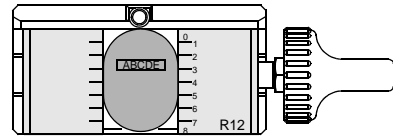
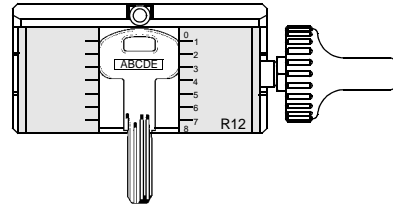
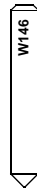

OPTIONAL STANDARD
TRIAX-E.CODE TRIAX 2

D734232ZB

R1+R12 clamp
Morsetto R1+R12
Spannbacken R1+R12
Étau R1+R12
Mordaza R1+R12

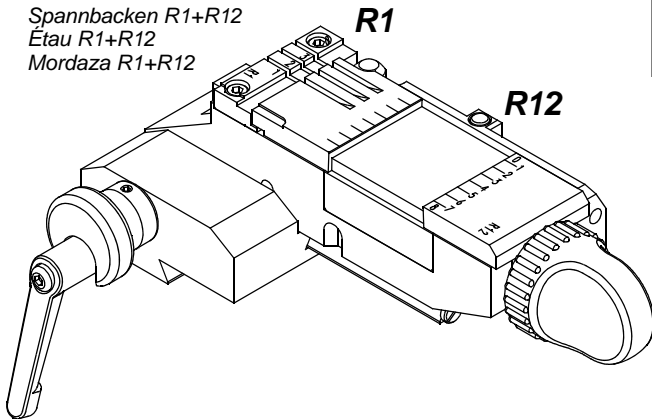

R1+R12

Double clamp: KEY CUTTING + ENGRAVING
Morsetto doppia funzione: CIFRATURA + INCISIONE
Doppelspannbacke: SCHLÜSSEL FRÄSEN + GRAVIEREN
Etau double fonction: TAILLE + GRAVURE
Mordaza doble función: TALLADO + GRABADO

D734267ZB

Cutter W146 (carbide)
Fresa W146 (metallo duro)
Fräser W146 (Hartmetall)
Fraise W146 (au carbure)
Fresa W146 (metal duro)

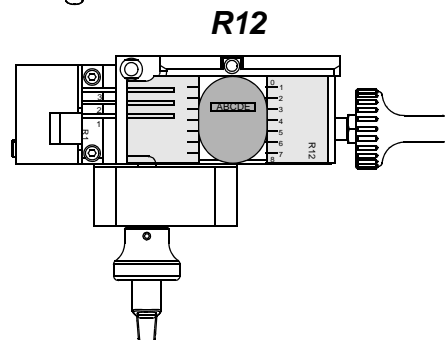
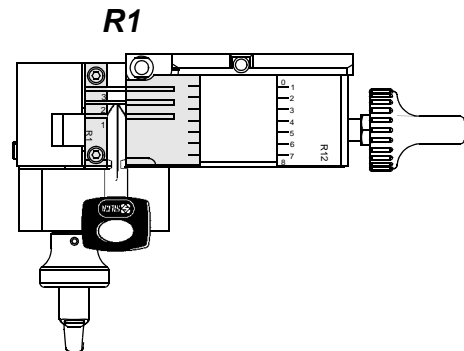

TRIAX-E.CODE

