

**Clamp "D" for flat vehicle keys - Morsetto "D" per chiavi piatte veicoli  
Spannbacke "D" für Auto-Flachschlüssel - Etai "D" pour clés plates véhicules  
Mordaza "D" para llaves planas vehículos - Mordente "D" para chaves planas veículos**

PER:  
FOR:

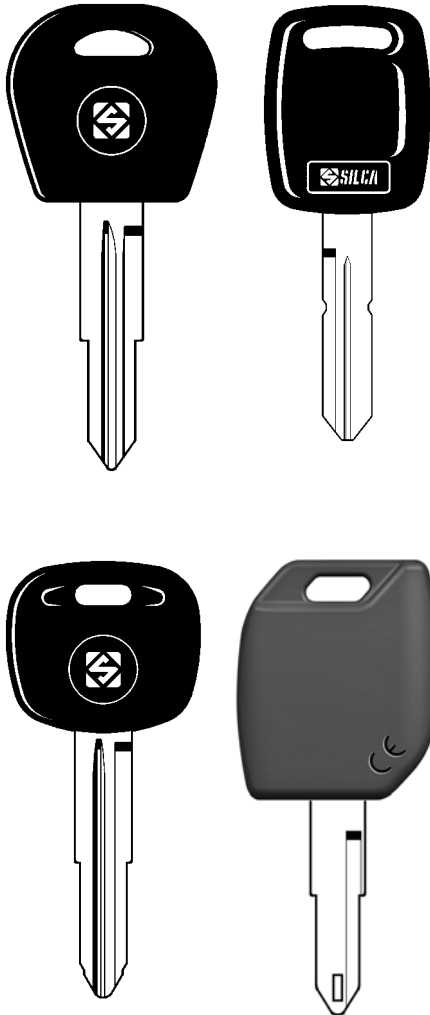

Over 368 profiles available of vehicle keys.  
Oltre 368 profili disponibili di chiavi per veicoli.  
Über 368 verfügbare von Auto-Schlüssel Profile.  
Plus de 368 profils disponibles de clés pour véhicules.  
Más de 368 perfiles disponibles de llaves para vehículos.  
Mais de 368 perfis disponíveis das chaves para veículos.

OPTIONAL



**D740050ZB**

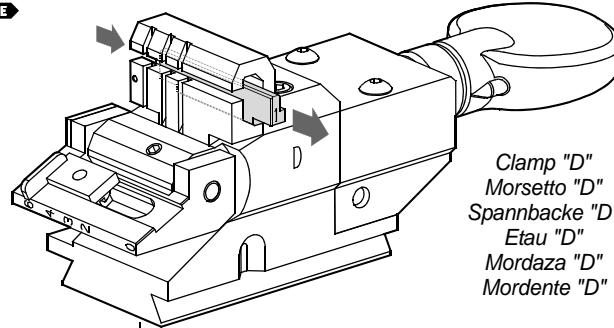

Clamp "D"  
Morsetto "D"  
Spannbacke "D"  
Etai "D"  
Mordaza "D"  
Mordente "D"

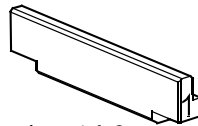

Insert 1-2  
Inserto 1-2  
Einsatz 1-2  
Insert 1-2  
Inserto 1-2  
Peça 1-2

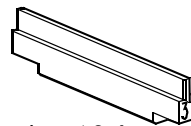

Insert 3-4  
Inserto 3-4  
Einsatz 3-4  
Insert 3-4  
Inserto 3-4  
Peça 3-4

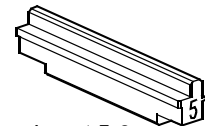

Insert 5-6  
Inserto 5-6  
Einsatz 5-6  
Insert 5-6  
Inserto 5-6  
Peça 5-6



**U113**

Tracer point  
Tastatore  
Taster  
Palpeur  
Palpador  
Palpador



**U113DC**

Decoder for vehicle keys  
Decodificatore per chiavi veicoli  
Decoder für Auto-Schlüssel  
Décodateur pour clés véhicules  
Descodificador para llaves vehículos  
Descodificador chaves veículos



**H158**

Cutter  
Fresino  
Fräser  
Fraise  
Fresa  
Fresa

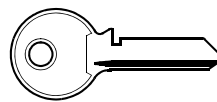

**Z3**

Template for calibration  
Dima di taratura  
Eichschablone  
Gabarit pour étalonnage  
Escantillon de ajuste  
Gabarito para ajuste



**CD Wintransfer**

- Clamp "D" can only be used on VIPER machines with SW version 1.2.018 DB 9.0 or later.
- Il morsetto "D" può essere utilizzato solo con duplicatrici VIPER aventi versione SW 1.2.018 DB 9.0 o superiore
- Die Spannbacke "D" kann nur mit Schlüsselkopiermaschinen VIPER mit SW-Version 1.2.018 DB 9.0 oder höher verwendet werden.
- L'étai "D" ne peut être utilisé que sur des duplicatrices VIPER dotées de la version SW 1.2.018 DB 9.0 ou postérieure.
- La mordaza "D" puede ser utilizada solo con duplicadoras VIPER con la versión SW 1.2.018 DB 9.0 o superior.
- O mordente "D" pode ser utilizado exclusivamente com máquinas duplicadoras VIPER com versão de SW 1.2.018 DB 9.0 ou superior.

PER:  
FOR:

## FORD (D)

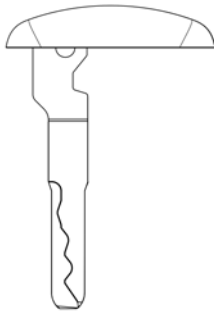

(Escape model)

### OPTIONAL

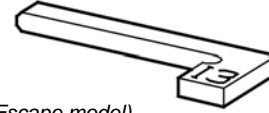

#### D741483ZB

Adapter I3 for FORD keys (Escape model)  
Adattatore I3 per chiavi FORD (modello Escape)  
Adapter I3 für FORD Schlüssel (Escape models)  
Adaptateur I3 pour clés FORD (modèle Escape)  
Adaptador I3 para llaves FORD (modelo Escape)  
Adaptador I3 para chaves FORD (modelo Escape)

### STANDARD



#### D709238ZB

Cutter W101 (carbide)  
Fresa W101 (metallo duro)  
Fräser W101 (Hartmetall)  
Fraise W101 (au carbure)  
Fresa W101 (metal duro)  
Fresa W101 (metal duro)

PER:  
FOR:

## RENAULT (F)

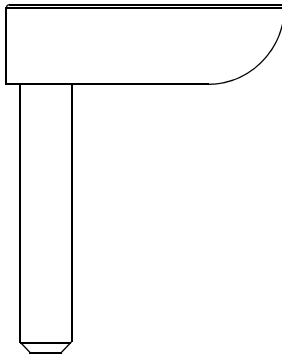

VALEO (F)

### OPTIONAL



#### D736123B

Adapter I1 for Renault keys  
Adattatore I1 per chiavi Renault  
Adapter I1 für Renault Schlüssel  
Adaptateur I1 pour clés Renault  
Adaptador I1 para llaves Renault  
Adaptador I1 para chaves Renault

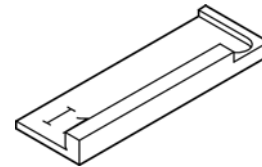

### STANDARD



#### D709238ZB

Cutter W101 (carbide)  
Fresa W101 (metallo duro)  
Fräser W101 (Hartmetall)  
Fraise W101 (au carbure)  
Fresa W101 (metal duro)  
Fresa W101 (metal duro)

PER:  
FOR:

## ZADI (I)

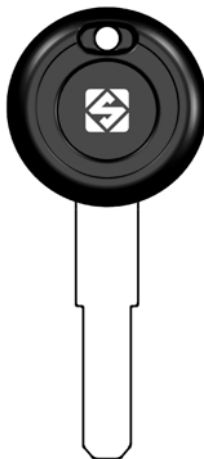

ZD30T5

### OPTIONAL



#### D738443ZB

Adapter I2 for ZD30T5 keys  
Adattatore I2 per chiavi ZD30T5  
Adapter I2 für ZD30T5 Schlüssel  
Adaptateur I2 pour clés ZD30T5  
Adaptador I2 para llaves ZD30T5  
Adaptador I2 para chaves ZD30T5

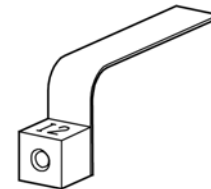

### OPTIONAL



#### D709481ZB

Cutter H114 (HSS)  
Fresa H114 (HSS)  
Fräser H114 (HSS)  
Fraise H114 (HSS)  
Fresa H114 (HSS)  
Fresa H114 (HSS)



#### D709482ZB

Cutter W114 (carbide)  
Fresa W114 (metallo duro)  
Fräser W114 (Hartmetall)  
Fraise W114 (au carbure)  
Fresa W114 (metal duro)  
Fresa W114 (metal duro)