

# CROWN / CROWN-15 / CROWN NO T10

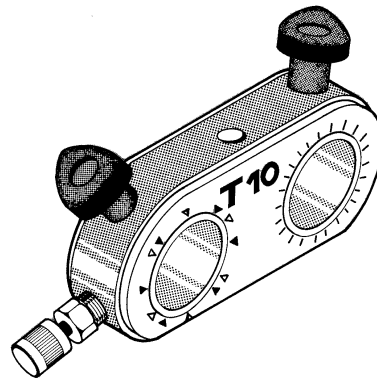

- PER:  
FOR:
- CENTURY (USA)**  
CEN5T (10)
  - CHICAGO (USA)**  
CH16T (9.2)  
CH17T (10)
  - MERONI (I)**  
MER22T (9.50)  
MER25T (9.50)
  - P.CORTELLEZZI (I)**  
PC12T (9.60)  
PC12TP (9.60)  
PC15T (9.60)  
PC15TP (9.60)
  - SILCA (I)**  
SLC1TP (9.60)  
SLC2TP (9.60)
  - SIDLEEN (USA)**  
SD3T (9.50)

- |          |          |              |
|----------|----------|--------------|
| STANDARD | OPTIONAL | OPTIONAL     |
| COPY     | COPY     | COPY         |
| CROWN    | CROWN-15 | CROWN NO T10 |



Ø UNIVERSAL  
mm 9,2 ... mm 10,2

**D700329ZB**  
"T10" device  
Set dispositivo "T10"  
"T10" Vorrichtung  
Dispositif "T10"  
Dispositivo "T10"

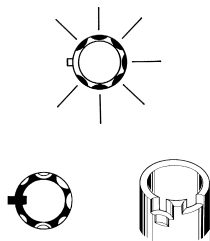
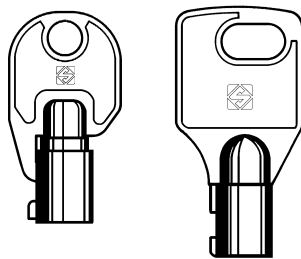

STEP CUTS

- |          |          |              |
|----------|----------|--------------|
| STANDARD | OPTIONAL | OPTIONAL     |
| COPY     | COPY     | COPY         |
| CROWN-15 | CROWN    | CROWN NO T10 |

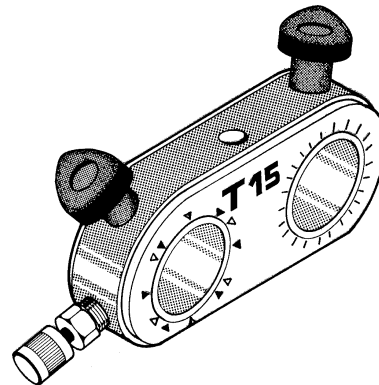

Ø UNIVERSAL  
mm 6 ... mm 12,5

**D705355ZB**  
"T15" device  
Set dispositivo "T15"  
"T15" Vorrichtung  
Dispositif "T15"  
Dispositivo "T15"

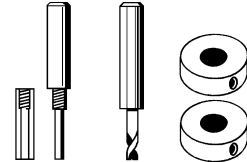

- PER:  
FOR:
- CHICAGO (USA)**

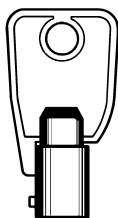

CH9T

- OPTIONAL
- COPY
- D707830ZB**  
CHICAGO code attachment  
Dispositivo a codice CHICAGO  
CHICAGO Code-Vorrichtung  
Dispositif à code CHICAGO  
Dispositivo a código CHICAGO

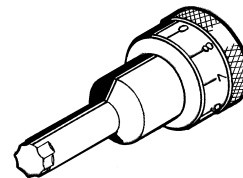

to fit on T10 - T15 devices  
da applicare ai dispositivi T10 - T15  
die auf T10 - T15 Code-Vorrichtung zu installieren  
à installer sur les dispositifs T10 - T15  
a instalarse en los dispositivos T10 - T15

- D709575ZB**  
Depth measuring devices  
Rilevatore di profondità  
Tiefenvermesser  
Relevateur de profondeurs  
Medidor de profundidad

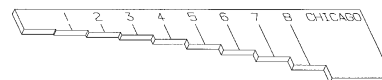

# CROWN / CROWN-15 / CROWN NO T10



PER:  
FOR:

**CAVITH (F)**

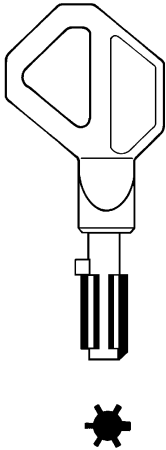

OPTIONAL



**D700199ZB**  
"T13" device  
Set dispositivo "T13"  
"T13" Vorrichtung  
Dispositif "T13"  
Dispositivo "T13"

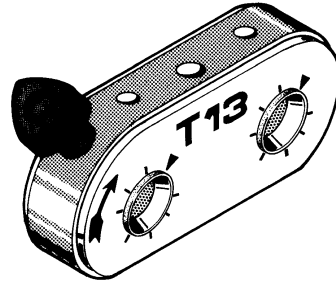

PER: **DAD-DECAYEUX (F)**

FOR:

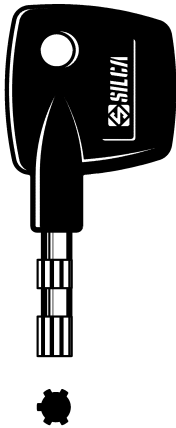

5DD1P

OPTIONAL

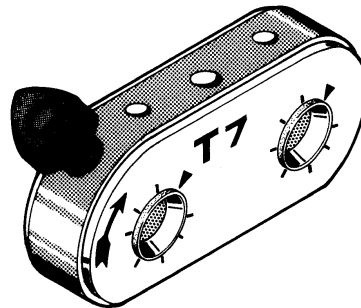

**D700194ZB**  
"T7" device  
Set dispositivo "T7"  
"T7" Vorrichtung  
Dispositif "T7"  
Dispositivo "T7"

**FTH (F)**

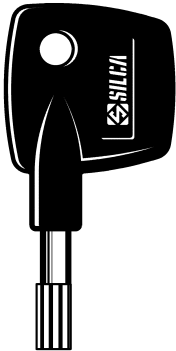

5FH1P



# CROWN / CROWN-15 / CROWN NO T10



PER:  
FOR:

**GB2 (I)**



OPTIONAL

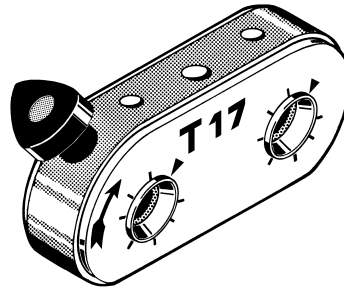

**D709355ZB**

Dispositivo "T17"  
"T17" device  
"T17" Vorrichtung  
Dispositif "T17"  
Dispositivo T17"

PER:  
FOR:

**JPM (F)**



5JM2P

OPTIONAL

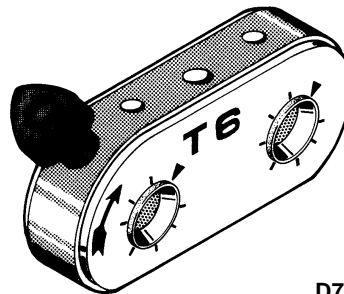

**D700193ZB**

"T6" device  
Set dispositivo "T6"  
"T6" Vorrichtung  
Dispositif "T6"  
Dispositivo "T6"

PER:  
FOR:

**LAPERCHE (F)**

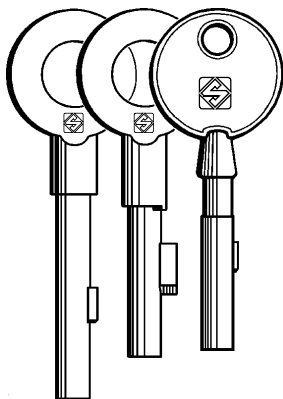

5LH3 5LH2 5LH1

OPTIONAL

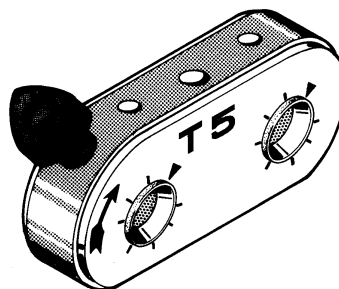

**D700192ZB**

"T5" device  
Set dispositivo "T5"  
"T5" Vorrichtung  
Dispositif "T5"  
Dispositivo "T5"



# CROWN / CROWN-15 / CROWN NO T10



PER:  
FOR:

## MERONI (I)

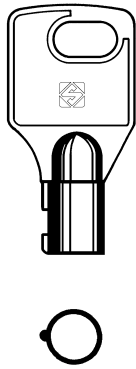

OPTIONAL



### D709345ZB

MERONI code attachment  
Dispositivo a codice MERONI  
MERONI Code-Vorrichtung  
Dispositif à code MERONI  
Dispositivo a código MERONI

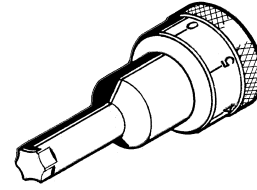

to fit on T10 - T15 devices  
da applicare ai dispositivi T10 - T15  
die auf T10 - T15 Code-Vorrichtung zu installieren  
à installer sur les dispositifs T10 - T15  
a instalarse en los dispositivos T10 - T15

### D709574ZB

Depth measuring devices  
Rilevatore di profondità  
Tiefenvermesser  
Relevateur de profondeurs  
Medidor de profundidad

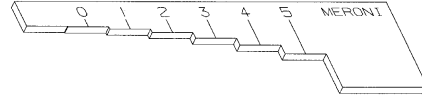

PER:  
FOR:

## PROGRES-FONTAINE (F) CORNI (I)

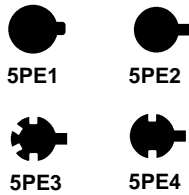
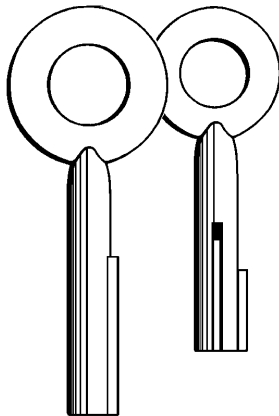

OPTIONAL

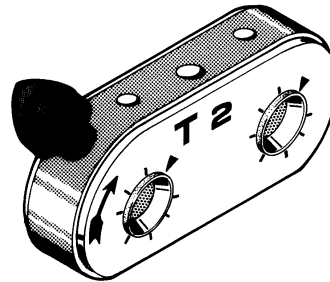

### D700189ZB

"T2" device  
Set dispositivo "T2"  
"T2" Vorrichtung  
Dispositif "T2"  
Dispositivo "T2"

PER:  
FOR:

## PROGRES-FONTAINE (F) CORNI (I)

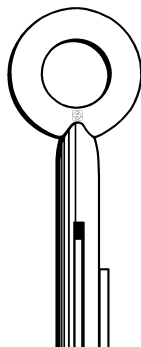

OPTIONAL

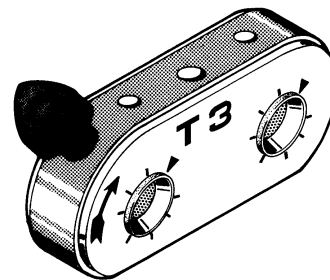

### D700190ZB

"T3" device  
Set dispositivo "T3"  
"T3" Vorrichtung  
Dispositif "T3"  
Dispositivo "T3"



# CROWN / CROWN-15 / CROWN NO T10



PER:  
FOR:

## POLLUX (F)

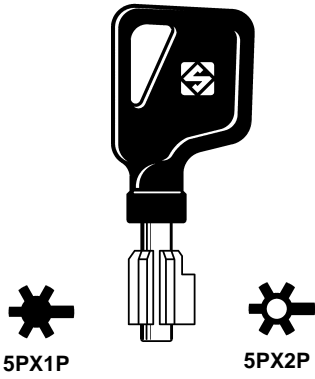

OPTIONAL

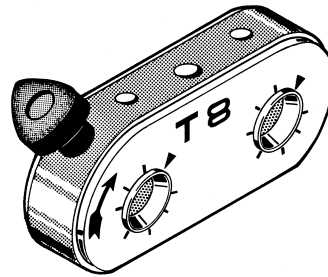

### D700195ZB

"T8" device  
Set dispositivo "T8"  
"T8" Vorrichtung  
Dispositif "T8"  
Dispositivo "T8"

OPTIONAL

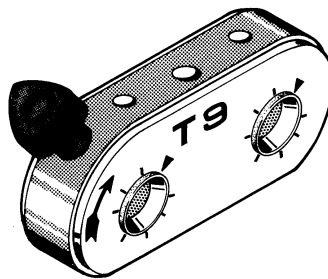
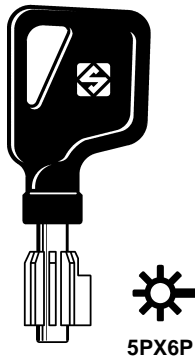

### D700196ZB

"T9" device  
Set dispositivo "T9"  
"T9" Vorrichtung  
Dispositif "T9"  
Dispositivo "T9"

PER:  
FOR:

## VIGIE PICARD (F)

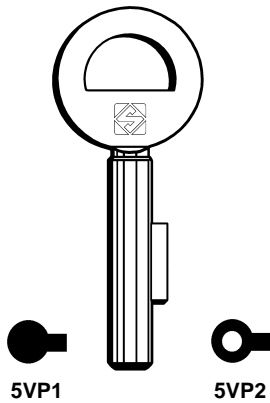

OPTIONAL

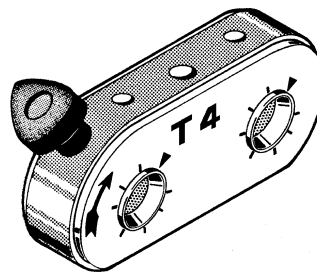

### D700191ZB

"T4" device  
Set dispositivo "T4"  
"T4" Vorrichtung  
Dispositif "T4"  
Dispositivo "T4"

OPTIONAL

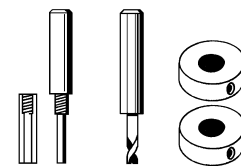
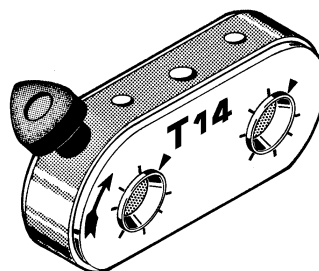
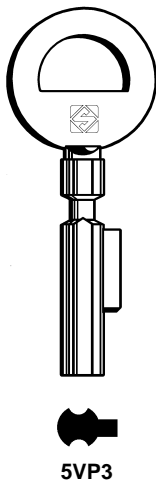

### D704534ZB

"T14" device  
Set dispositivo "T14"  
"T14" Vorrichtung  
Dispositif "T14"  
Dispositivo "T14"



**ATTENTION:** for repairs or replacement of parts for maintenance, the 'CE' mark is guaranteed only if original spare parts provided by the manufacturer are used.

**ATTENZIONE:** in caso di riparazioni o sostituzione di pezzi per manutenzione, la marcatura "CE" è garantita solo se vengono utilizzate parti di ricambio originali fornite dal costruttore.

**ACHTUNG:** bei Reparaturen oder Auswechseln von Teilen zur Instandhaltung wird die CE-Markierung nur bei Verwendung von vom Hersteller gelieferten Originalersatzteilen gewährleistet.

**ATTENTION:** si vous effectuez des réparations ou que vous remplacez des pièces pendant un entretien, le marquage "CE" n'est garanti que si vous utilisez des pièces de rechange originales fournies par le fabricant.

**ATENCIÓN:** en caso de reparaciones o sustituciones de las piezas por mantenimiento, se garantiza la marca "CE" sólo si se utilizan partes de repuesto originales suministradas por el constructor.



**SILCA S.p.A.**

Via Podgora, 20 (Z.I.) 31029 VITTORIO VENETO (TV)

Tel. 0438 9136 Fax 0438 913800

[www.silca.it](http://www.silca.it)

Member of the Kaba Group

**KABA**<sup>®</sup>