

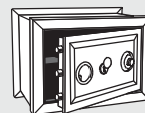

Safe keys
Chiavi per casseforti
Safeschlüssel
Clés pour coffre-forts
Llaves para cajas fuertes
Chaves para cofres

FOR:
PER:

MASCHI e FEMMINE per CASSAFORTE



65

FOR/PER

BODE (D)

CAWI (D)

SELLA & VALZ (68)

GLITTENBERG (D)

SECURITAS (I)

STIEHM (D)

FOR/PER:
SECURITAS

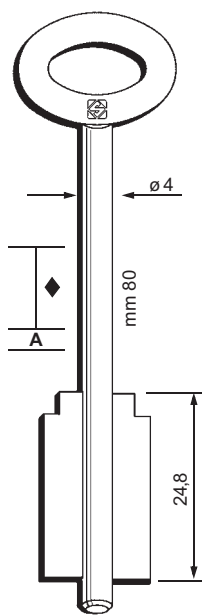

7508/1

FOR/PER:
SECURITAS

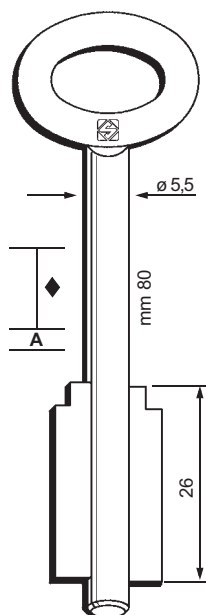

7508/2

FOR/PER:
BODE

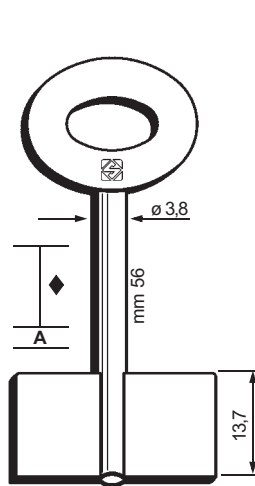

8456

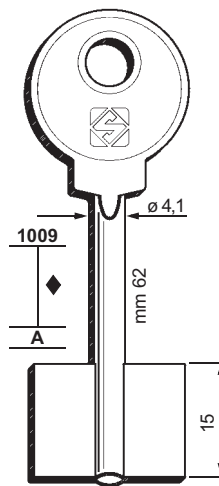

5BDE2

FOR/PER:
STIEHM

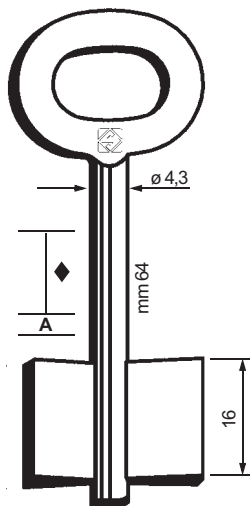

7161STM

FOR/PER:
GLITTENBERG

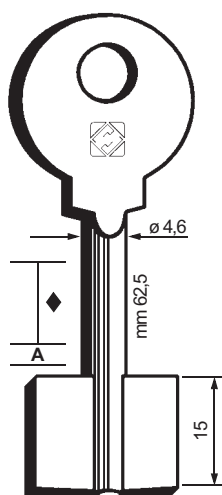

G464

FOR/PER:
STIEHM

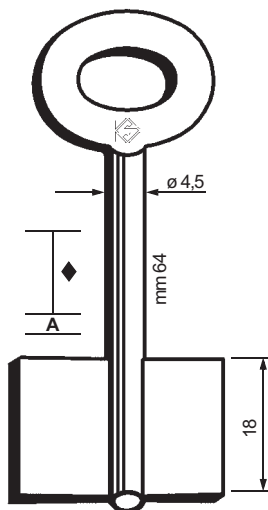

8164STM

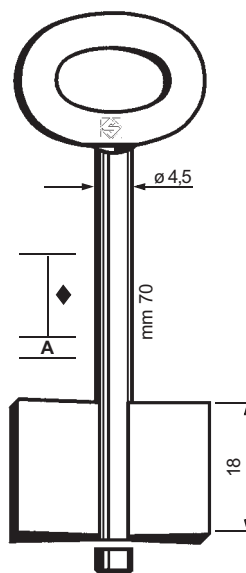

7107



8107

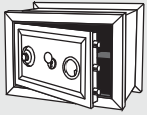

66

FOR/PER

FUMEO PARMA (I)

HAGELIN (S)

MELSMETALL (D)

SWEDEN (S)

FOR:
PER:

MASCHI e FEMMINE per CASSAFORTE

FOR/PER:
HAGELIN

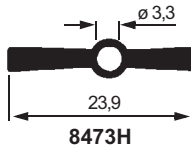
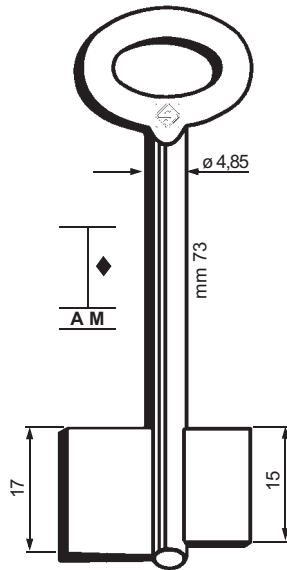
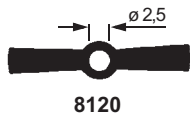
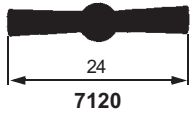
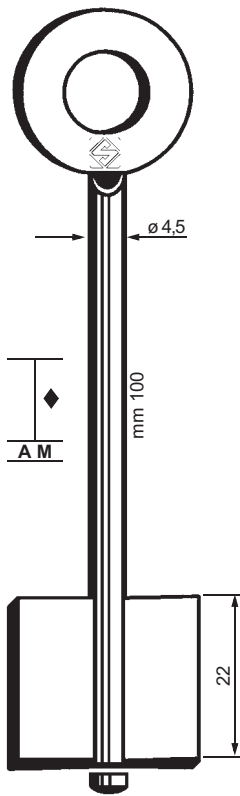

FOR/PER:
SWEDEN

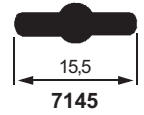
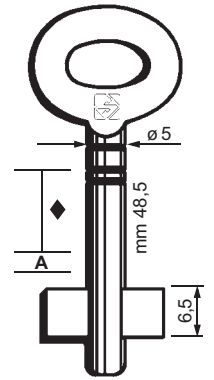
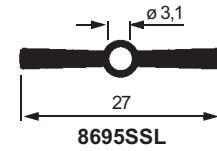
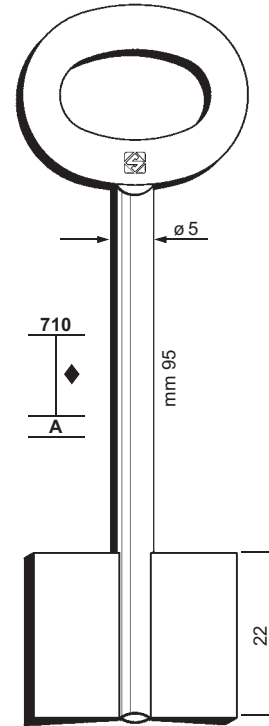

FOR/PER:
FUMEO-PARMA

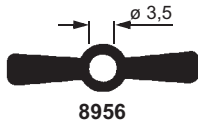
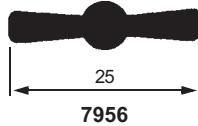
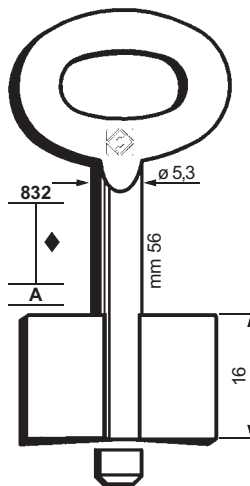
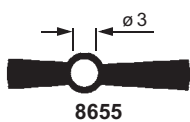
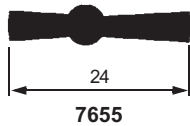
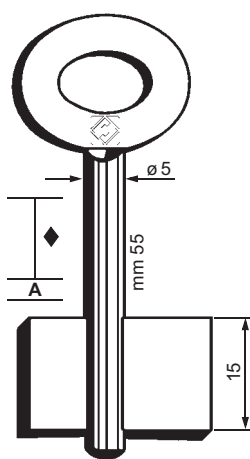

FOR/PER:
MELSMETALL

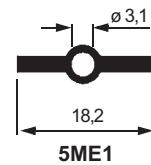
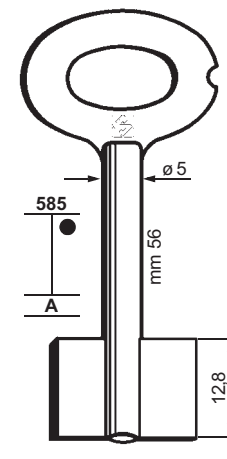

FOR/PER:
FUMEO-PARMA

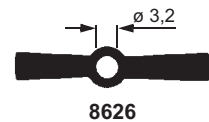
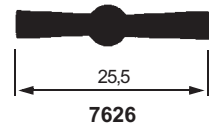
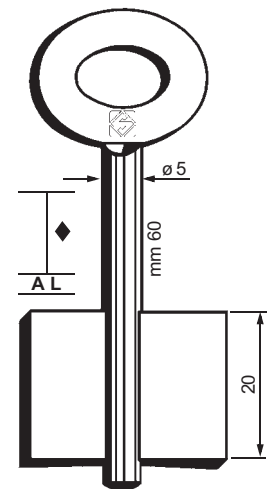

FOR:
PER:

MASCHI e FEMMINE per CASSAFORTE

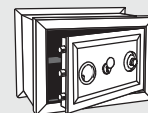

67

FOR/PER

BODE (D)

FASTA (I)

KROMER (D)

SOLID (ZA)

FOR/PER:
FASTA

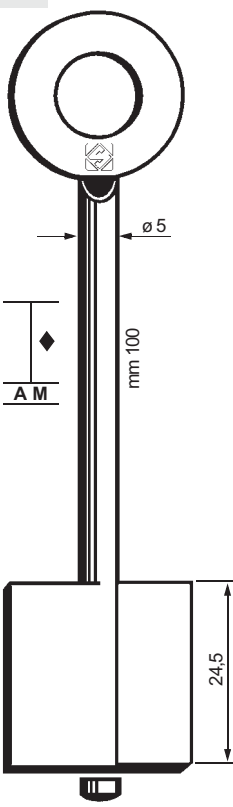
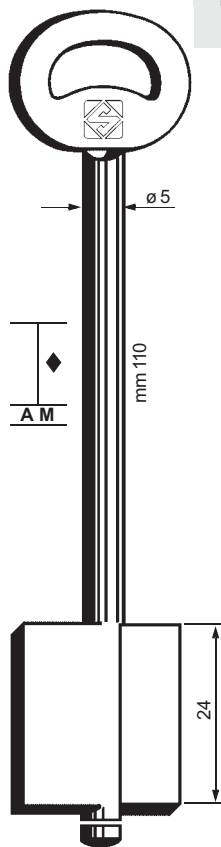

FOR/PER:
SOLID

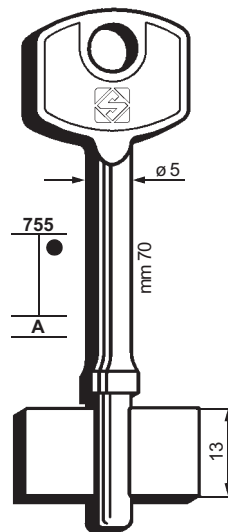

FOR/PER:
FASTA

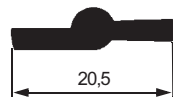
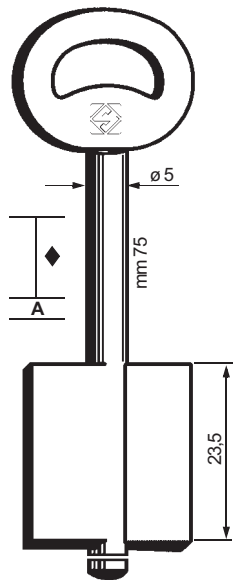

7150

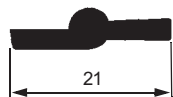

7151

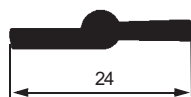

8110

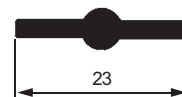

5SOL2

FOR/PER:
SOLID

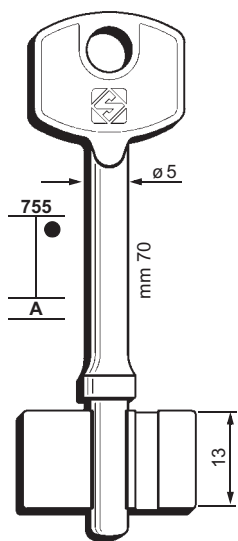

FOR/PER:
KROMER

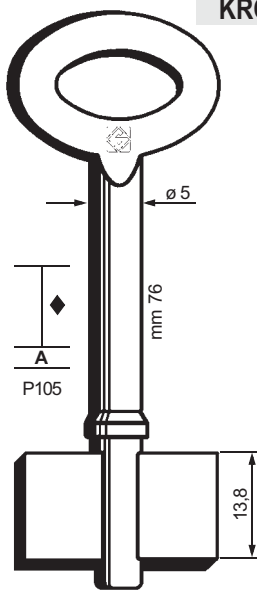

FOR/PER:
BODE

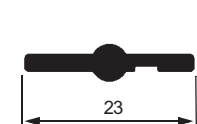
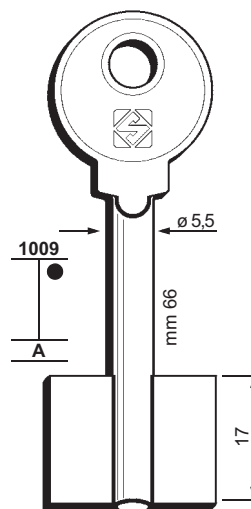

5SOL3

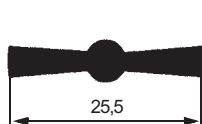

G86K

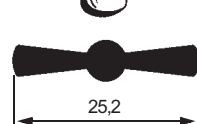

G85K

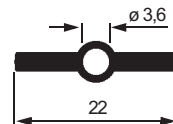

5BDE3

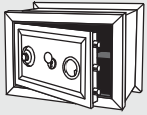

68

FOR/PER

SELLA & VALZ (I)
CAWI
WITTKOPP

FOR:
PER:

MASCHI e FEMMINE per CASSAFORTE

FOR/PER:
SELLA & VALZ

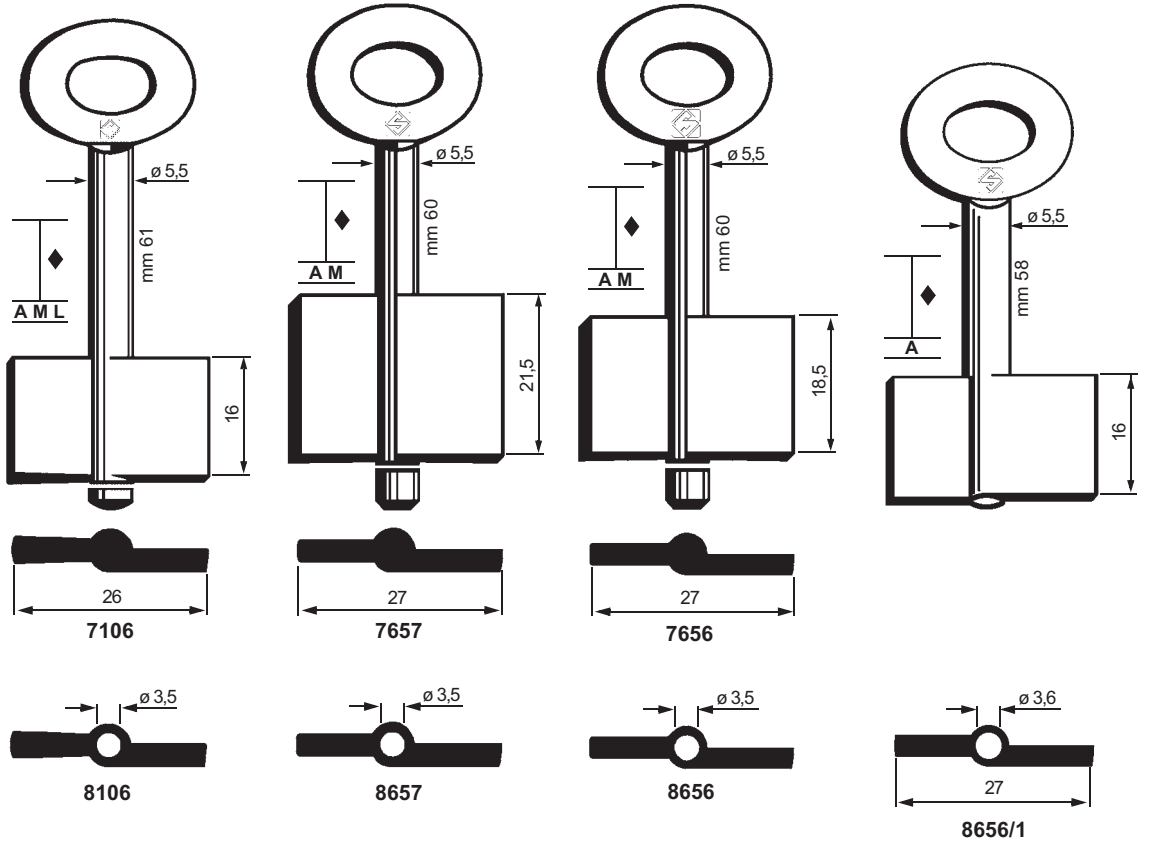

FOR/PER:
SELLA & VALZ

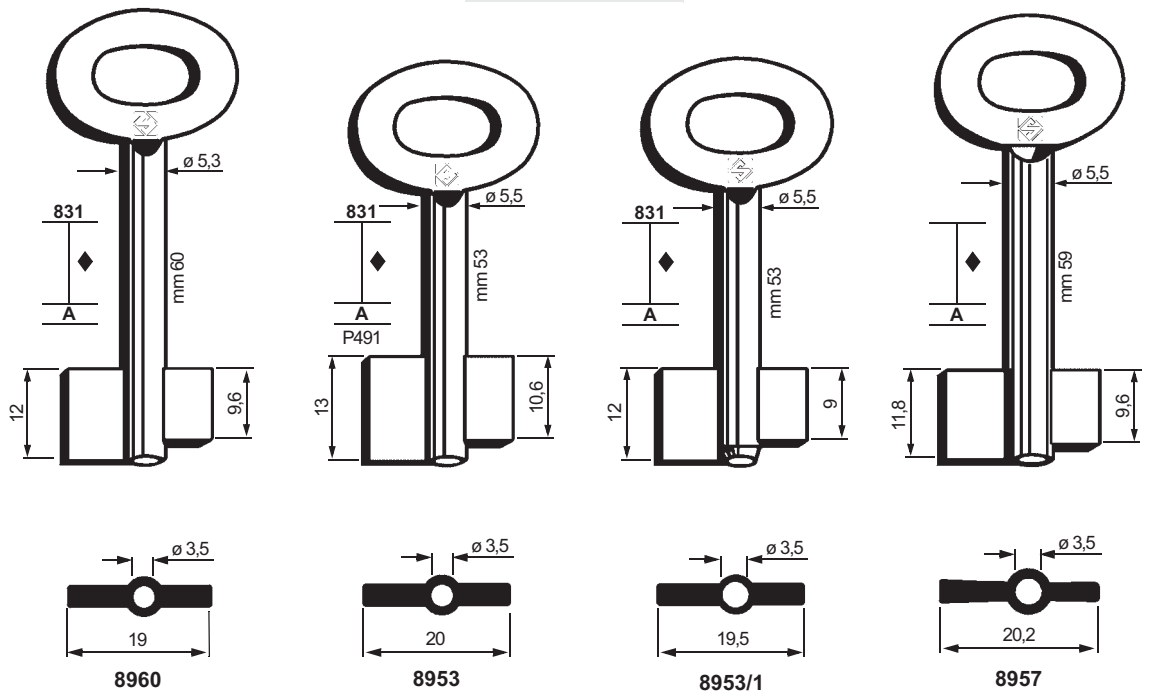

CAWI - WITTKOPP

FOR:
PER:

MASCHI e FEMMINE per CASSAFORTE

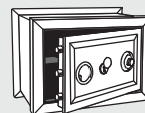

69

FOR/PER

CECCHERELLI (I)

FUMEO-PARMA (I)

STIEHM (D)

FOR/PER:
STIEHM

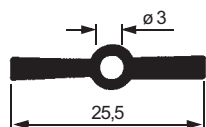
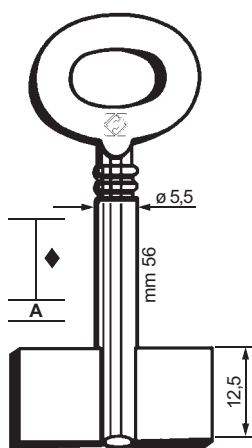

8156STM

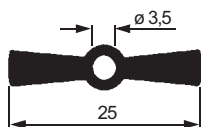
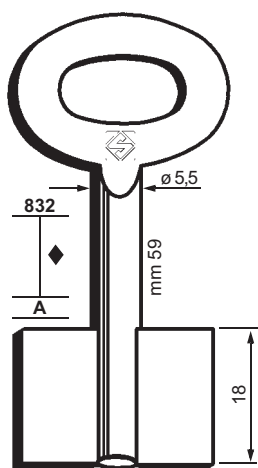

8958

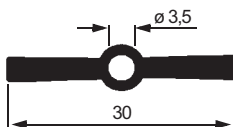
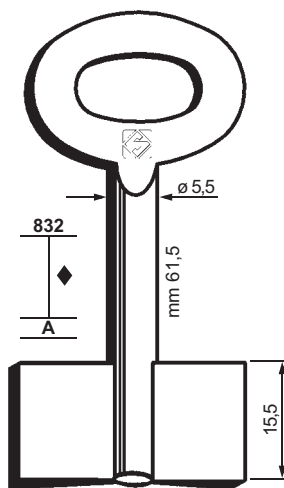

8958/1

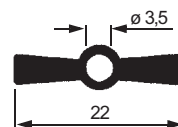
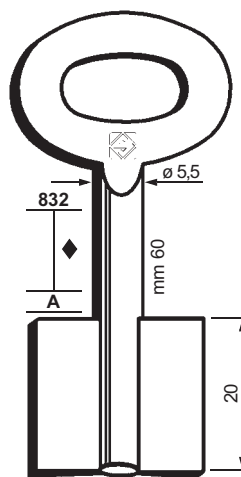

8961

FOR/PER:
STIEHM

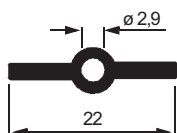
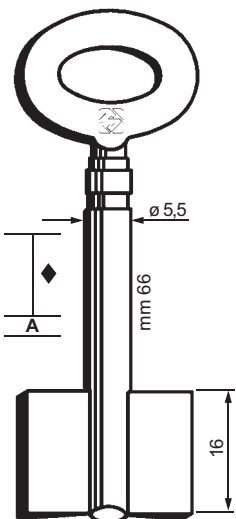

8166STM

FOR/PER:
CECCHERELLI

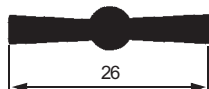
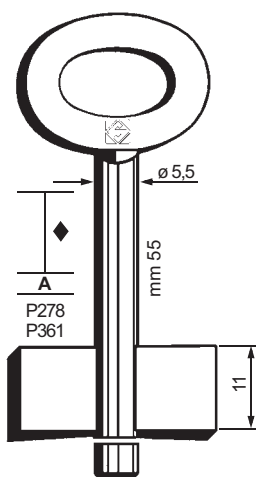

7455



8455

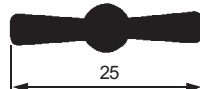
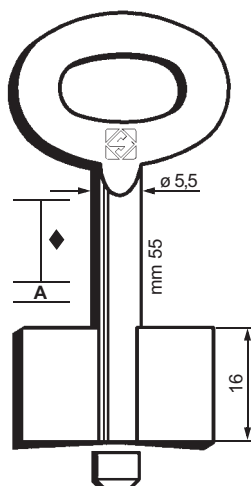

7956/1



8956/1

FOR/PER:
FUMEO-PARMA

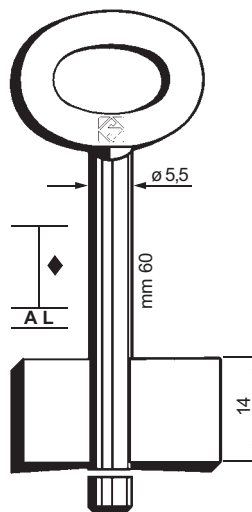

7606



8606

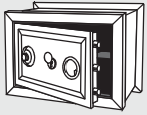

70

FOR/PER

ASSA (S)

ELZETT (H)

SIBI (I)

STUV (D)

TANN (D)

FOR:
PER:

MASCHI e FEMMINE per CASSAFORTE

FOR/PER:
SIBI

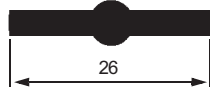
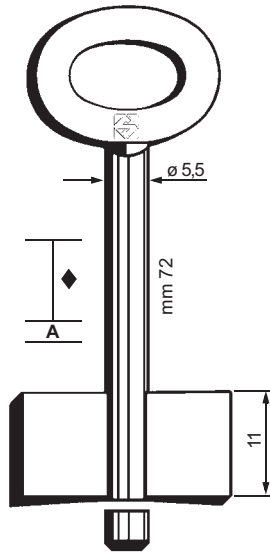

7659



8659

FOR/PER:
ELZETT

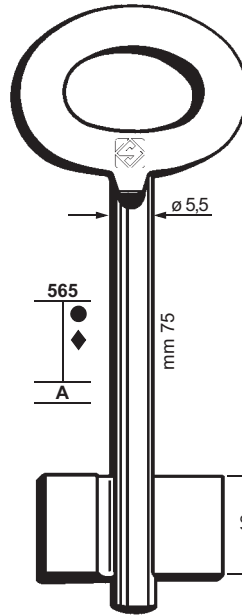

7308E

FOR/PER:
STUV-TANN

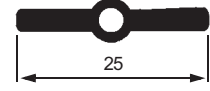
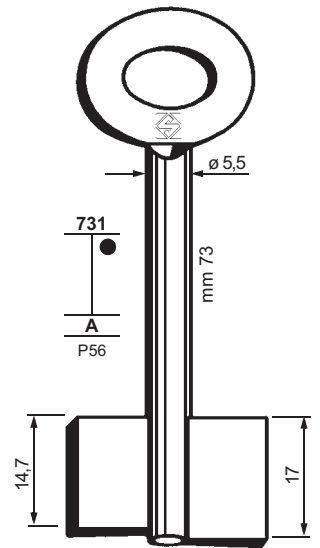

8372TA

FOR/PER:
STUV-TANN

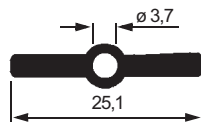
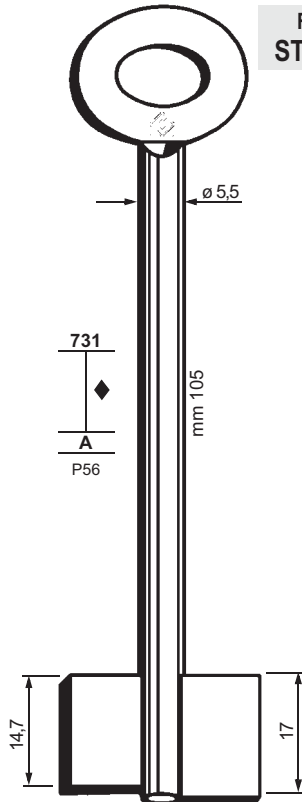

8310TA

FOR/PER:
ASSA

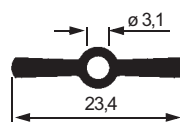
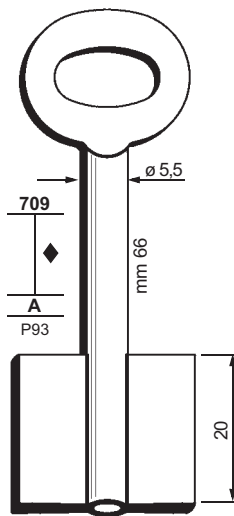

8466ASS

FOR/PER:
ASSA

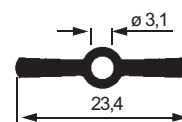
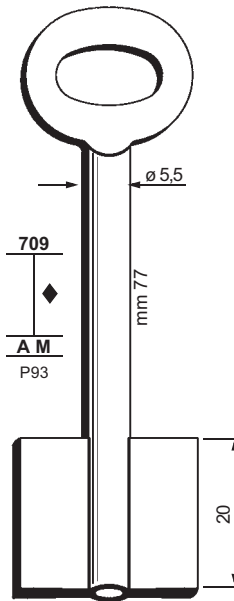

8477ASS

FOR/PER:
ASSA

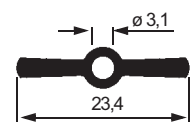
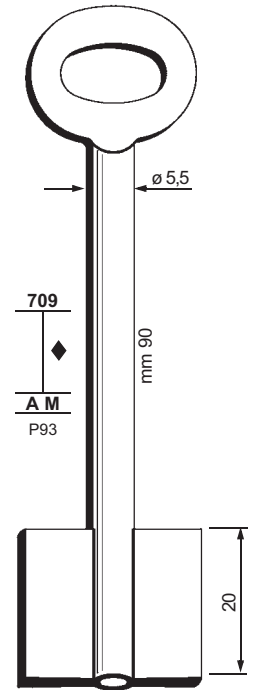

8490ASS

FOR:
PER:

MASCHI e FEMMINE per CASSAFORTE

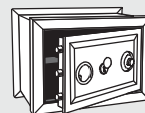

71

FOR/PER:
ROSENGREN

FOR/PER:
ROSENGREN

FOR/PER:
LIPS-VAGO

FOR/PER

CONFORTI (I)

LIPS-VAGO (I)

ROSENGREN (S)

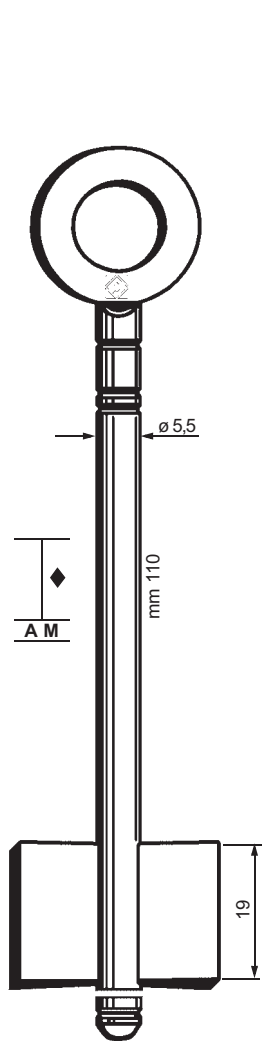

7211

8211

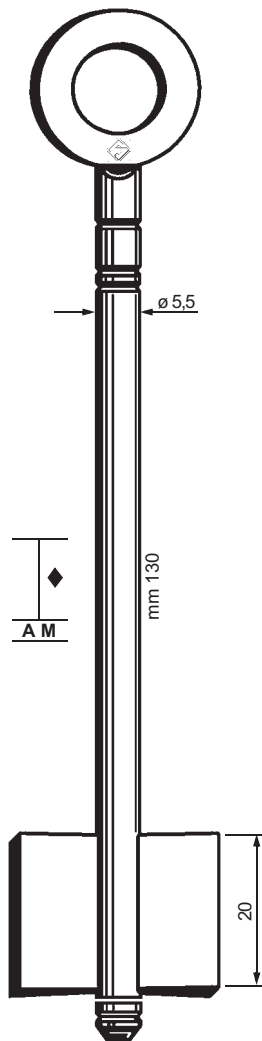

7213

8213

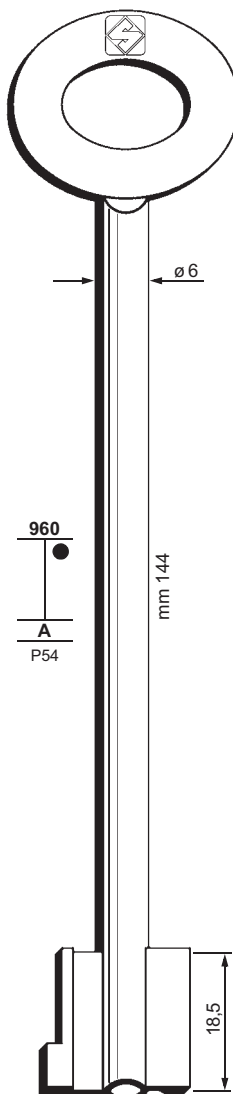

5RSG1

FOR/PER:
CONFORTI

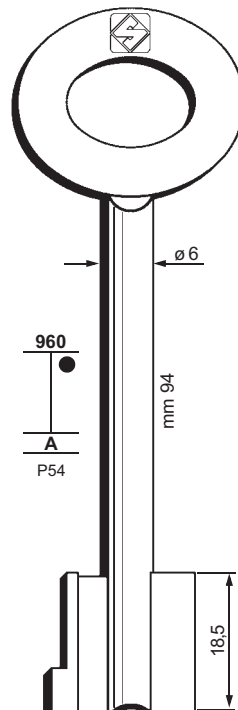

5RSG2

FOR/PER:
LIPS-VAGO

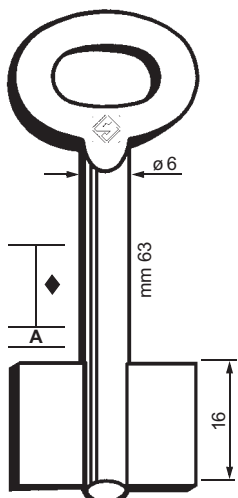

8963

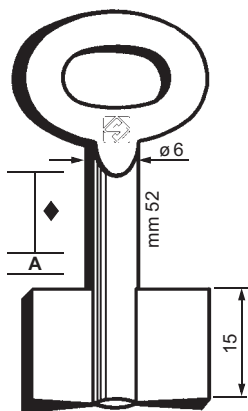

8951

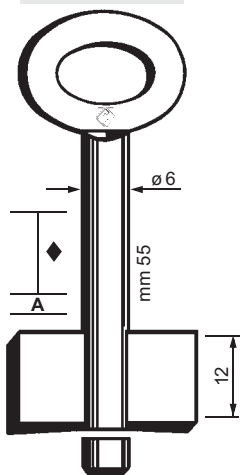

8405



7405

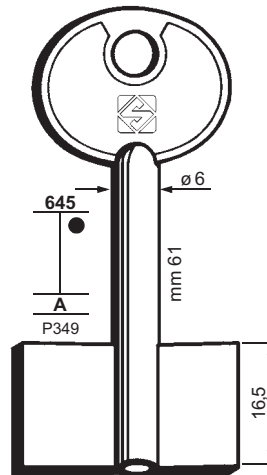

5LV1

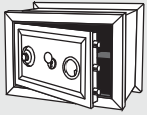

72

FOR/PER

CONFORTI (I)

PARMA-PAS (I)

SECURCASA (I)

FOR:
PER:

MASCHI e FEMMINE per CASSAFORTE

FOR/PER:
PARMA-PAS

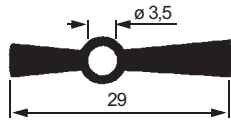
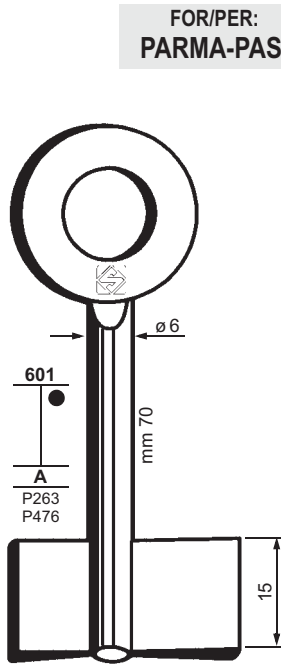

8370PA

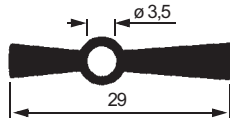
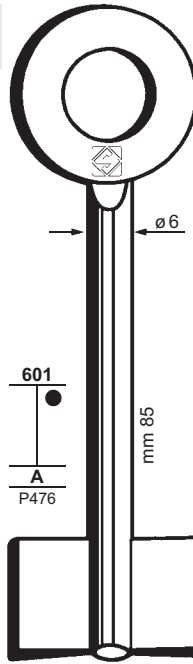

8385PA

FOR/PER:
SECURCASA

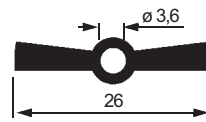
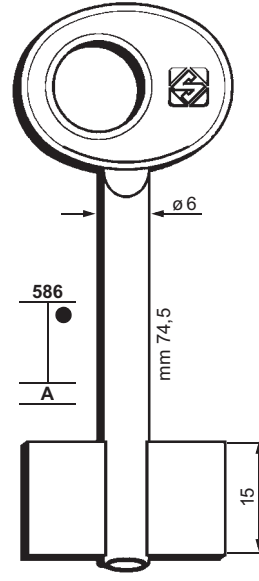

8367S

FOR/PER:
CONFORTI

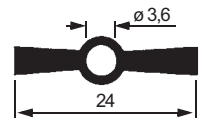
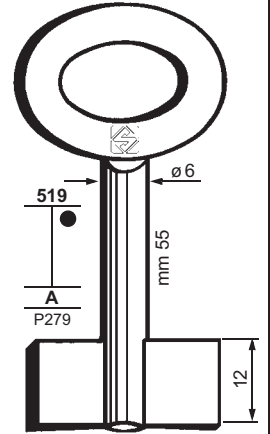

8355C

FOR/PER:
CONFORTI

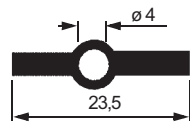
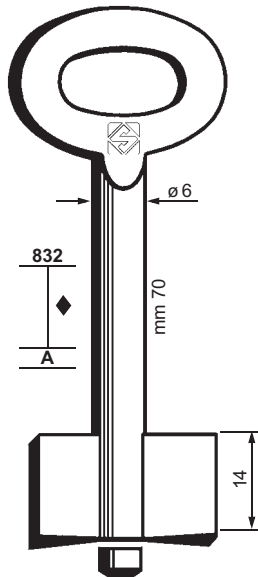

8972



7972

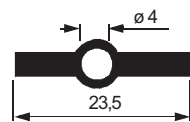
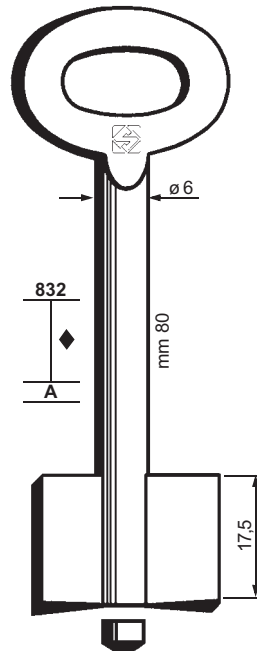

8980



7980

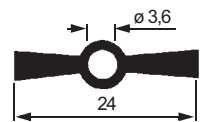
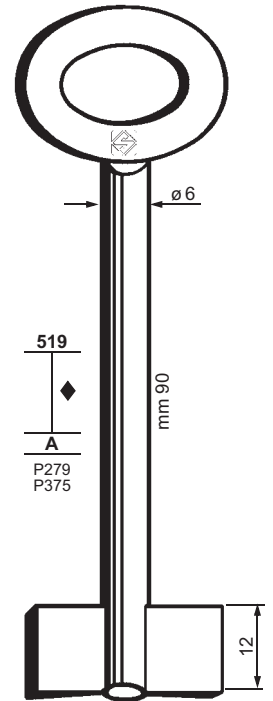

8388C

FOR:
PER:

MASCHI e FEMMINE per CASSAFORTE

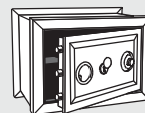

73

FOR/PER:
ROLEX

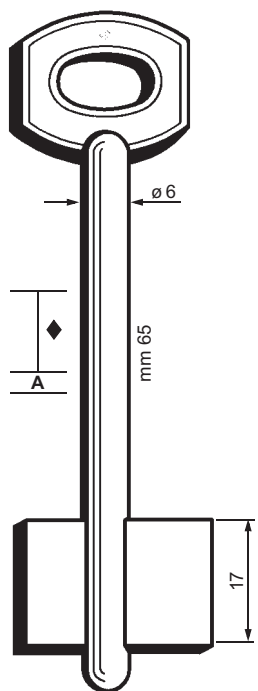

FOR/PER:
MELSMETALL

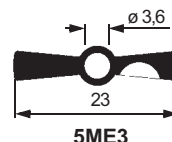
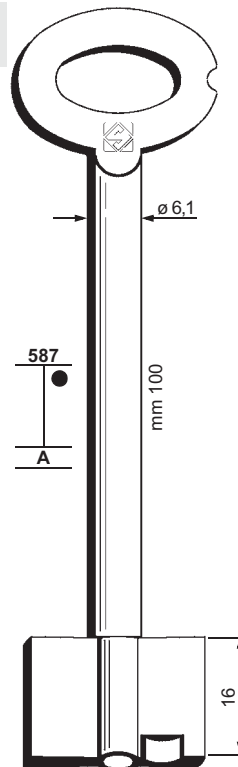
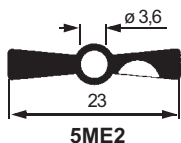
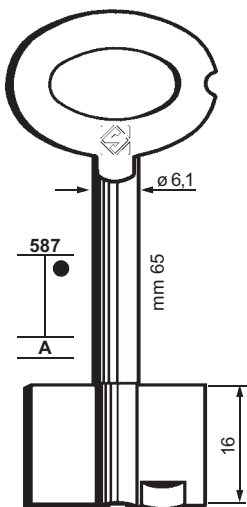

FOR/PER:
CONFORTI

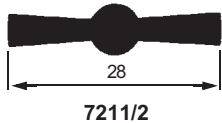
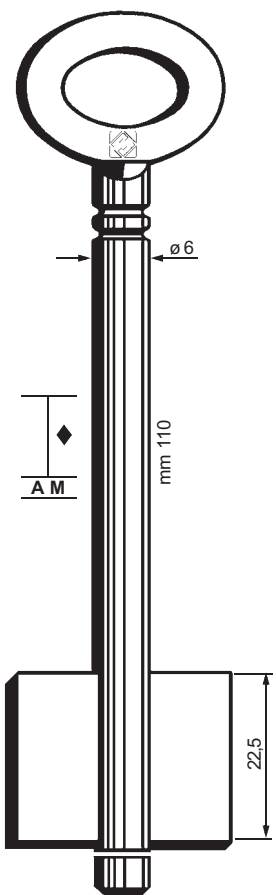

7211/2

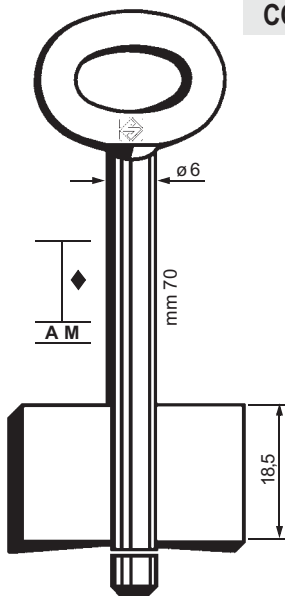

7207

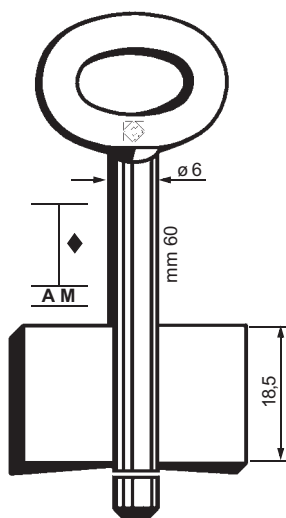

7206

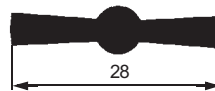
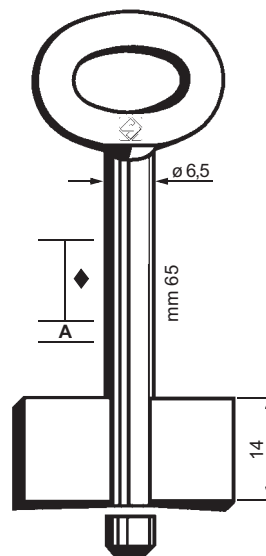

7406



8211/2



8207



8206



8406

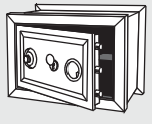

74

FOR/PER
STIEHM (D)

FOR:
PER:

MASCHI e FEMMINE per CASSAFORTE

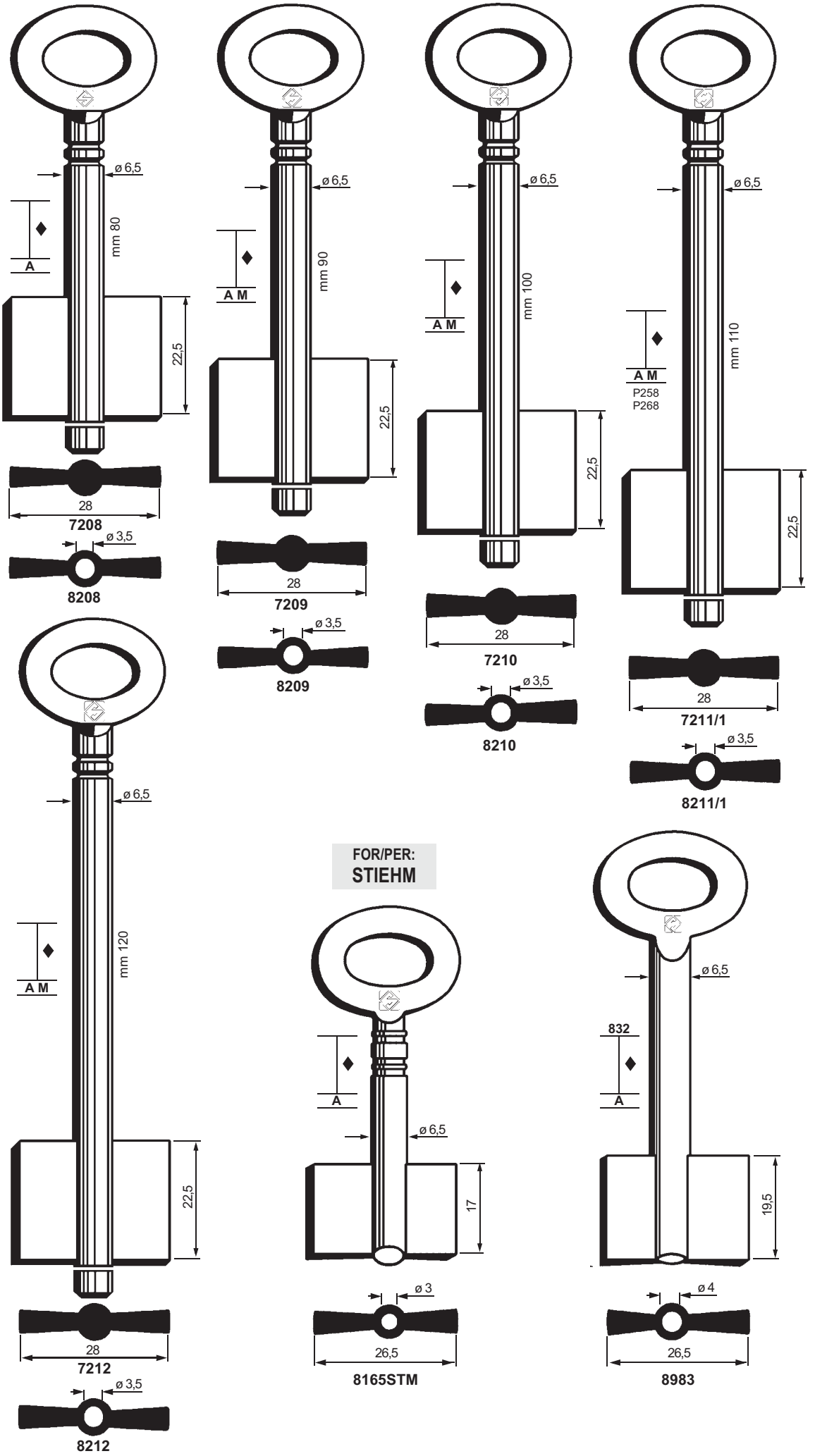

FOR/PER:
STIEHM

FOR:
PER:

MASCHI e FEMMINE per CASSAFORTE

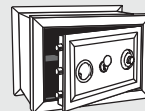

75

FOR/PER
STIEHM (D)

FOR/PER:
STIEHM

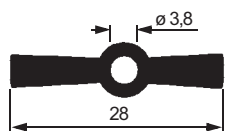
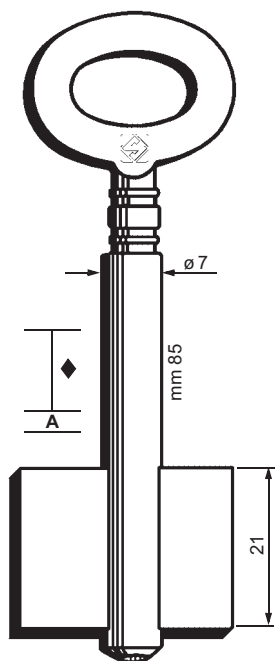

8181STM

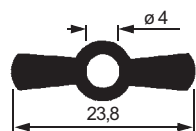
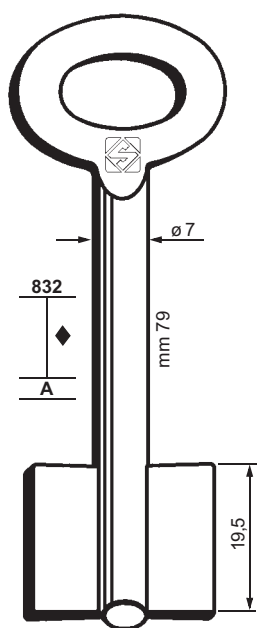

8977

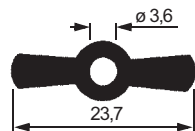
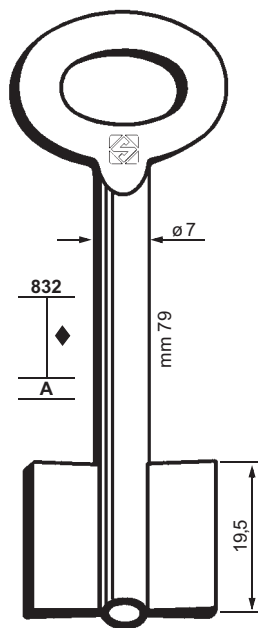

8978

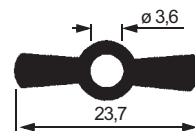
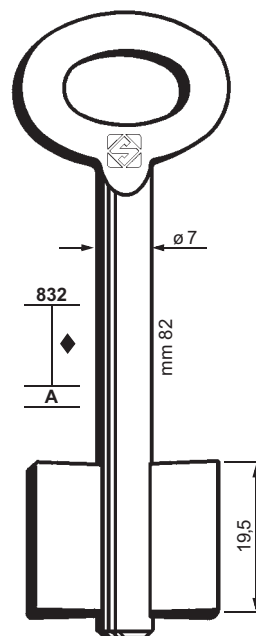

8978/1

FOR/PER:
STIEHM

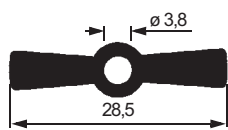
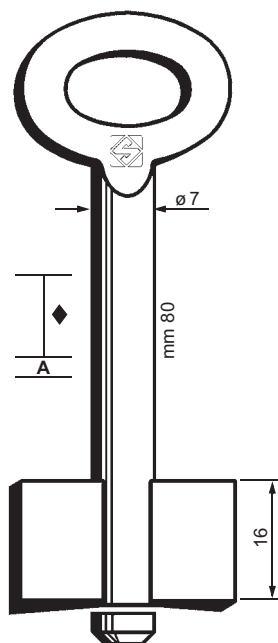

8979

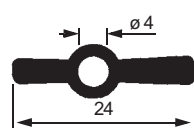
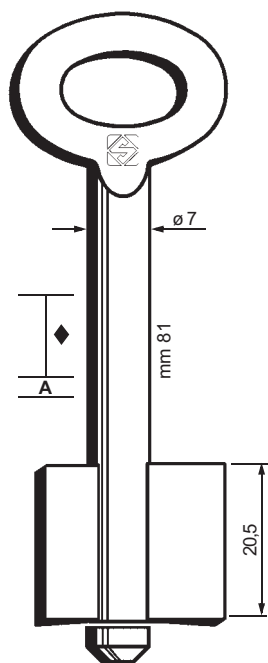

8981

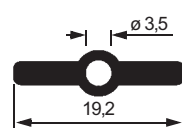
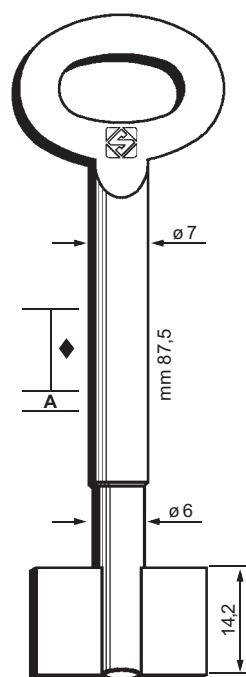

8990

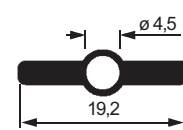
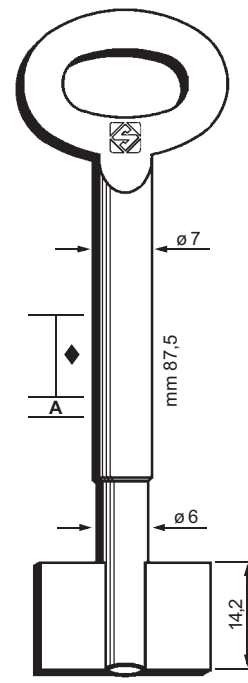

8990/1



7979



7981

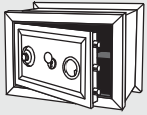

76

FOR/PER
CORBIN (I)
PARMA (I)

FOR:
PER:

MASCHI e FEMMINE per CASSAFORTE

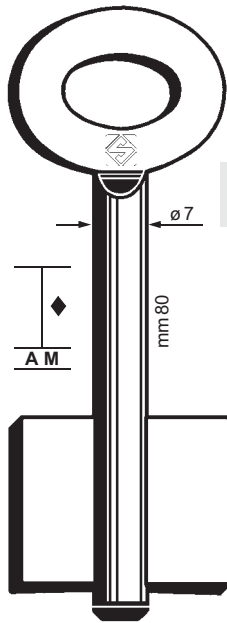

FOR/PER:
CORBIN

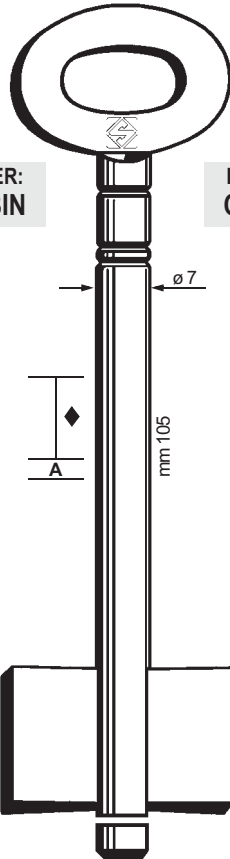

FOR/PER:
CORBIN

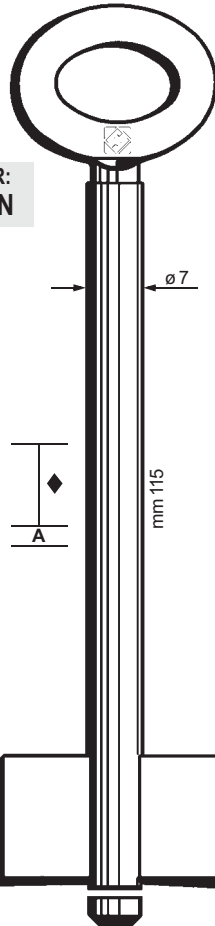

FOR/PER:
PARMA

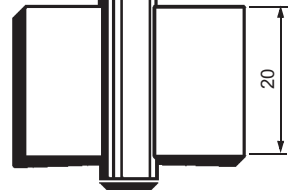
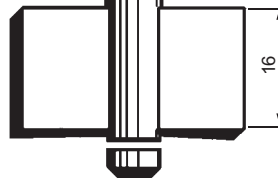
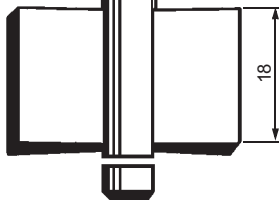
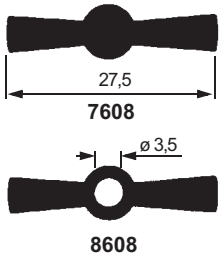
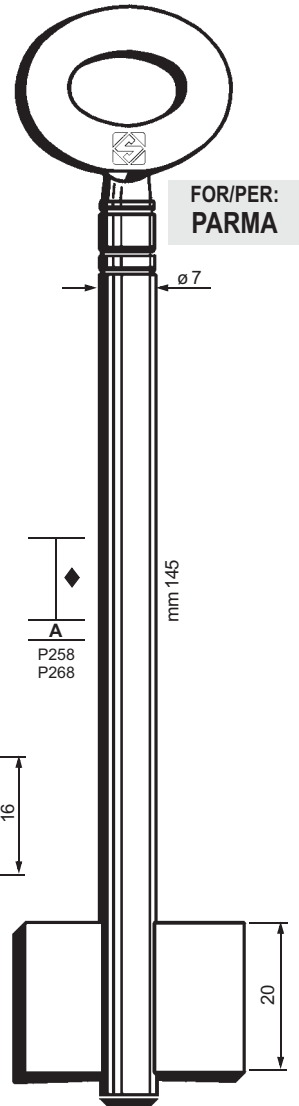

FOR/PER:
PARMA

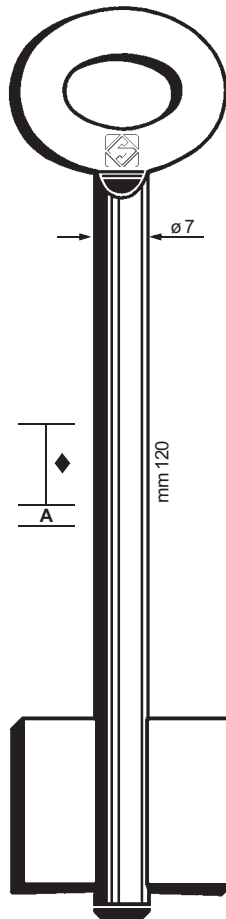
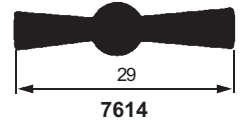
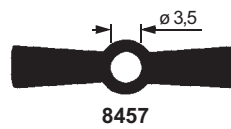
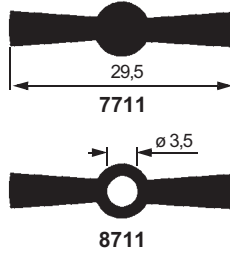

FOR/PER:
CORBIN

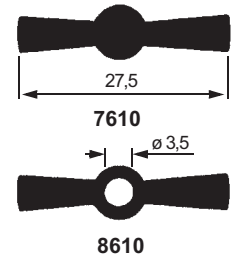
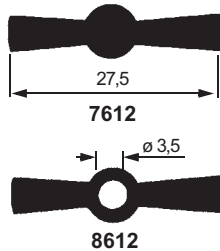
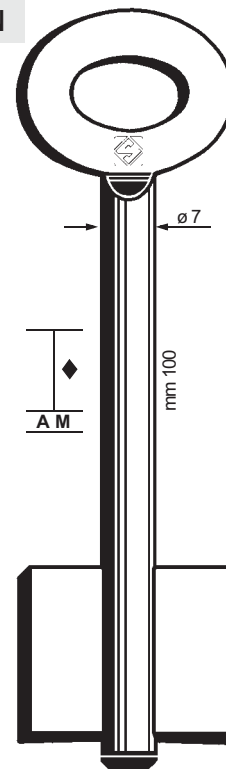

FOR:
PER:

MASCHI e FEMMINE per CASSAFORTE

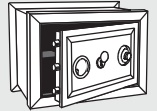

77

FOR/PER
DUTO (l)

FOR/PER:
DUTO

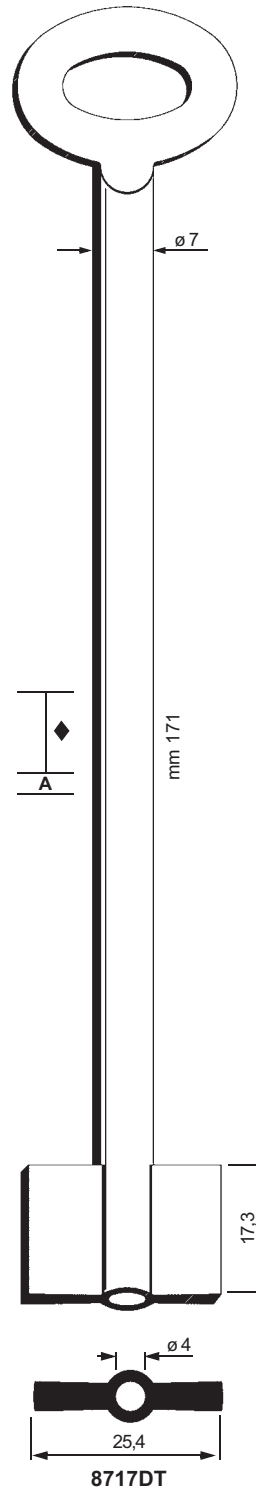

FOR/PER:
DUTO

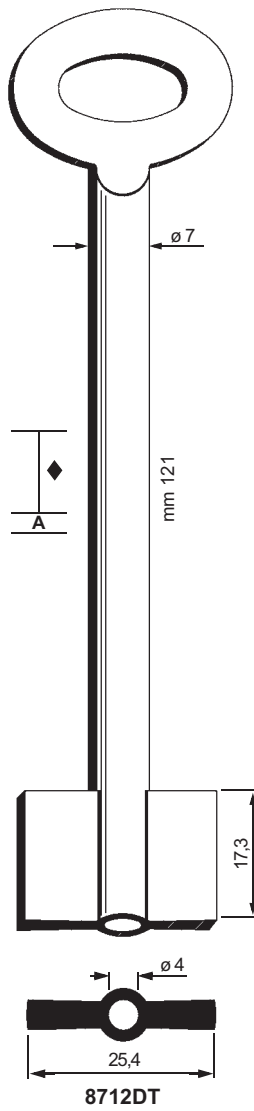

FOR/PER:
DUTO

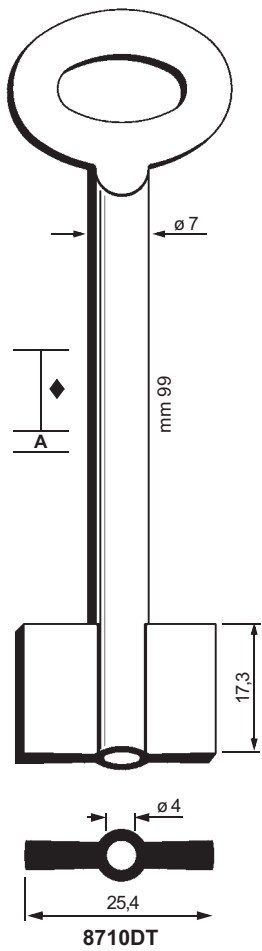

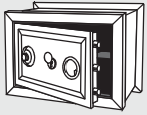

78

FOR/PER

DUTO (I)

PARMA-PAS (I)

FOR:
PER:

MASCHI e FEMMINE per CASSAFORTE

FOR/PER:
DUTO

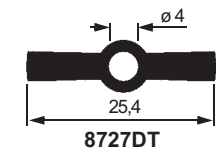
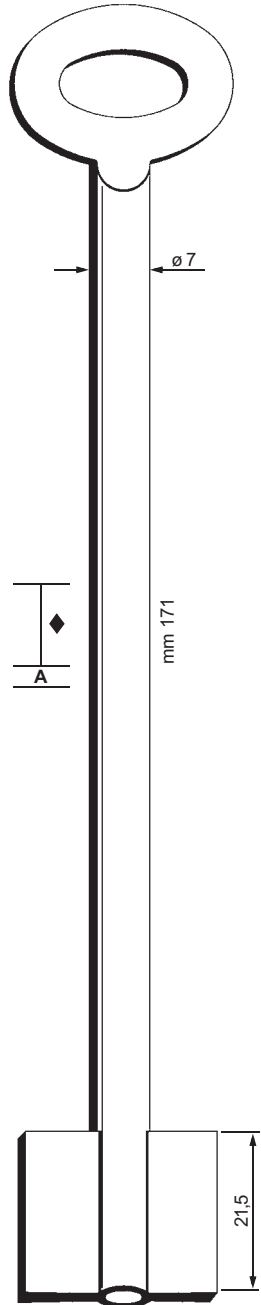

8727DT

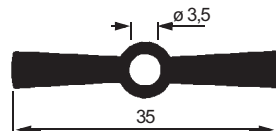
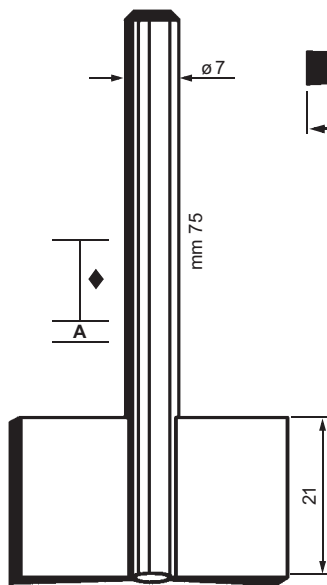

8808/1

FOR/PER:
PARMA-PAS

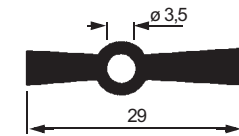
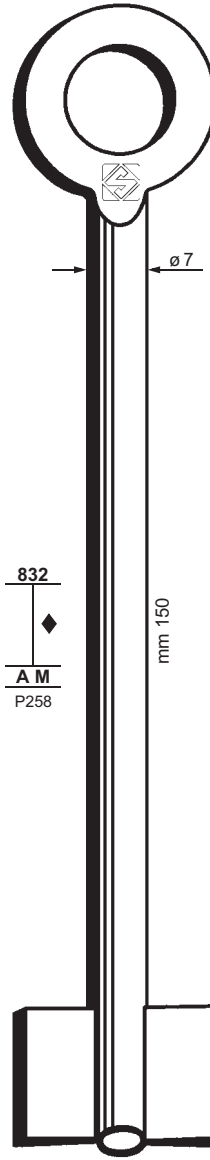

8615

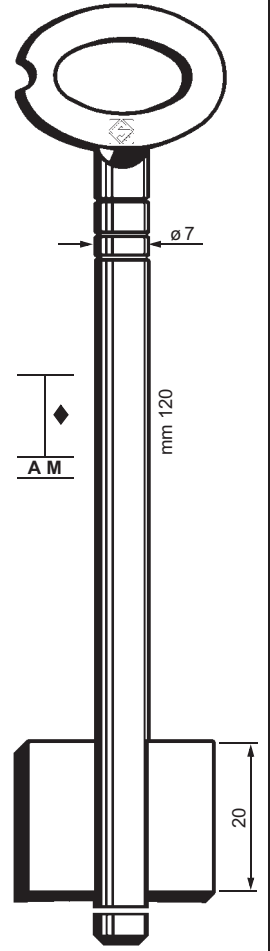

7712

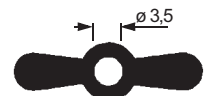

8712

FOR:
PER:

MASCHI e FEMMINE per CASSAFORTE

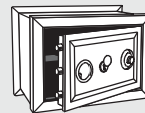

79

FOR/PER

WERTHEIM (D)

WITTKOPP (D)

SELVA & VALZ (68)

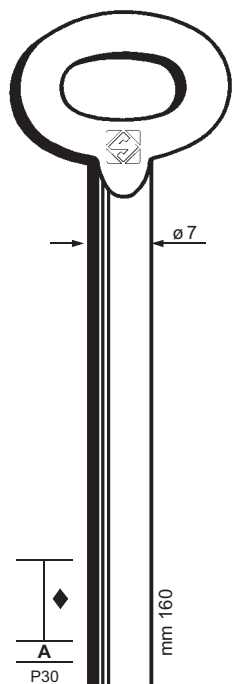

FOR/PER:
WERTHEIM

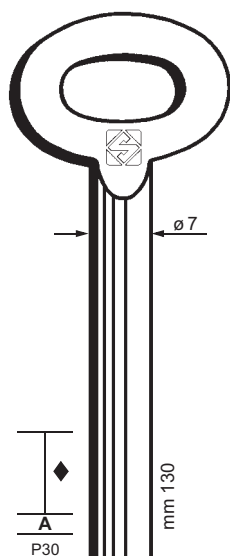
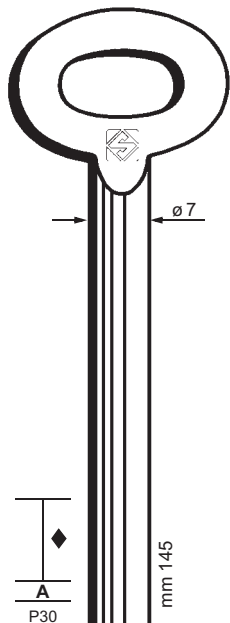

FOR/PER:
WERTHEIM

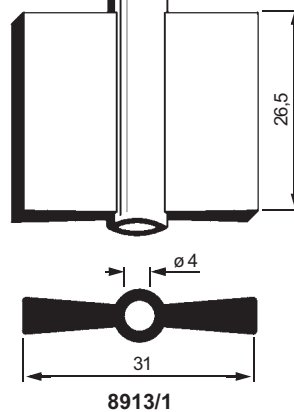
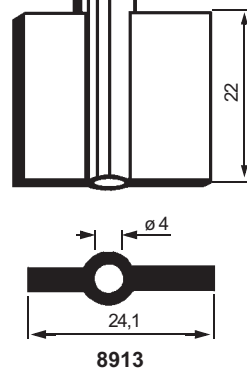
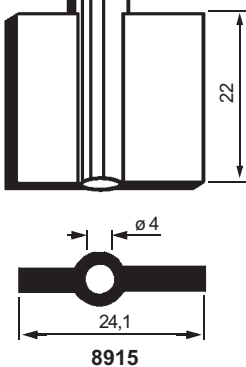
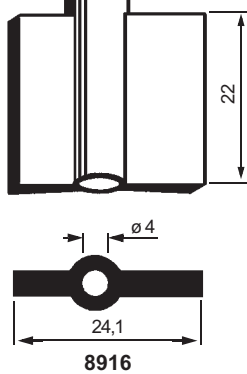
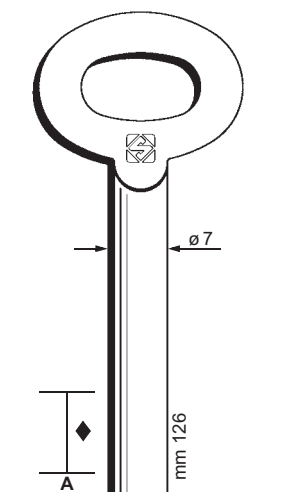



GB IMPORTANT

All information and illustrations in this catalogue are for guidance only.

Silca reserves the right to alter products designs, dimensions or info to improve the products quality.

The contents of this catalogue are fully protected by Copyright and may not be copied or reproduced in any form, without written permission from Silca.

Any infringements will be dealt with under Italian law.

F IMPORTANT

Les illustrations et les caractéristiques techniques des produits présentés dans ce catalogue sont données à titre indicatif.

Bien que les caractéristiques essentielles des produits soient invariables, Silca se réserve le droit d'apporter toutes les modifications qu'elle retiendra nécessaires et opportunes afin d'améliorer la qualité de ses produits.

Tous les dessins et photos sont propriété Silca et toute reproduction, même partielle, sans l'autorisation écrite préalable de Silca est interdite conformément aux prescriptions légales. Tout litige est du ressort exclusif des Tribunaux de la circonscription où se trouve le Siège de la Société.

I IMPORTANT

Le illustrazioni e i dati tecnici dei prodotti contenuti nel catalogo debbono considerarsi indicativi.

Silca si riserva il diritto, ferme restando le caratteristiche essenziali dei prodotti, di apportare tutte le modifiche che ritiene necessarie e opportune al fine di migliorare la qualità dei prodotti.

Tutti i disegni e le fotografie sono di proprietà di Silca, ogni riproduzione anche parziale, senza autorizzazione scritta della Silca è vietata secondo termini di legge.

Per qualsiasi controversia competenti sono gli Uffici Giudiziari dove ha sede l'Azienda, con espressa esclusione di qualsiasi altro foro.

E IMPORTANTE

Las ilustraciones y los datos técnicos de los productos en este catálogo son indicativos.

La Silca se reserva el derecho, quedando invariadas las características principales de los productos, de modificar todo lo que considere necesario y oportuno para mejorar la calidad de sus artículos.

Todos los dibujos y las fotografías pertenecen a la Silca; según determina la Ley, se prohíbe toda reproducción aunque parcial, sin autorización por escrito de la Silca.

En caso de disputas la competencia es de las autoridades judiciales donde está domiciliada la firma, excluyendo cualquier otro foro.

D WICHTIG

Die Abbildungen und technischen Daten des Katalogs sind nur zur Information.

Silca behält sich vor, etwaige Änderungen am Produkt, die zur Verbesserung desselben beitragen vorzunehmen.

Alle Zeichnungen und Fotos sind Besitz der Firma Silca, jede Reproduktion, auch teilweise, ist ohne schriftliche Erlaubnis der Firma Silca gesetzlich untersagt.

Im Falle von Streitfragen ist der Gerichtshof des Firmensitzes zuständig; jeder andere Gerichtshof ist ausgeschlossen.

P IMPORTANTE

As ilustrações e as características técnicas dos produtos apresentados neste catálogo são facultados a título indicativo.

Mesmo que as características essenciais dos produtos sejam invariáveis, à Silca reserva-se o direito de modificar ser necessário e oportuno los productos, afim de melhorar a sua qualidade.

Todos os desenhos e fotos são propriedade da Silca, e é proibida a sua reprodução mesmo parcial sem a autorização escrita da Silca conforme as prescrições legais.

Em caso de litígio fica desde já designado, excluindo qualquer outro, o Tribunal da comarca onde está registada a sede da Silca.

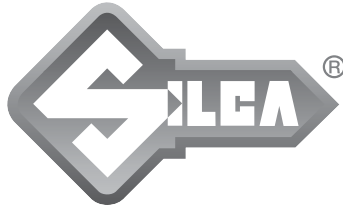
**GB IMPORTANT**

In compliance with current regulations relating to industrial property, we hereby state that the trade-marks or trade names mentioned in our catalogue are the exclusive property of authorized manufacturers of locks and users.

Said trade-marks or trade names are nominated only for the purposes of information so that any lock for which our keys are made can be rapidly identified.

This catalogue is reserved exclusively for professional key cutters who use Silca products.

I IMPORTANT

In conformità alle disposizioni legali in vigore relative alle proprietà industriali, informiamo che i marchi o le denominazioni commerciali citate nel nostro catalogo sono di proprietà esclusiva dei fabbricanti di serrature e degli utilizzatori autorizzati.

Questi marchi o denominazioni commerciali sono indicati a titolo di semplice informazione, con lo scopo di riconoscere velocemente a quali serrature le nostre chiavi sono destinate.

Questo catalogo è esclusivamente riservato ai professionisti della riproduzione chiavi che utilizzano i prodotti Silca.

D WICHTIG

Gemäß den derzeit geltenden Normen bezüglich des Industrieigentums teilen wir Ihnen mit, daß die im vorliegenden Katalog angeführten Markennamen oder Handelsmarken ausschließliches Eigentum der Schloßhersteller und zugelassenen Fachhändler sind.

Diese Markenbezeichnungen oder Handelsmarken sind nur zur Information angeführt, mit dem Zweck, schnell erkennen zu können, zu welchem Schloß unsere Schlüssel gehören.

Der vorliegende Katalog ist ausschließlich an Schlüsselkopier-Fachgeschäfte, die Silca Produkte benutzen, gerichtet.

F IMPORTANT

Conformément aux lois en vigueur concernant la propriété industrielle, nous vous informons que les marques et appellations commerciales citées dans notre catalogue appartiennent exclusivement aux fabricants de serrures et aux utilisateurs autorisés.

Ces marques ou appellations commerciales sont indiquées à titre d'information pure et simple pour vous permettre de déterminer rapidement les serrures auxquelles nos clés sont destinées.

Ce catalogue est réservé exclusivement aux professionnels du taillage de clés qui utilisent les produits Silca.

E IMPORTANTE

En conformidad con las vigentes disposiciones de ley sobre propiedad industrial, las marcas y denominaciones comerciales citadas en nuestro catálogo se declaran de propiedad exclusiva de los fabricantes de cerraduras y los utilizadores autorizados.

Dichas marcas o denominaciones comerciales se citan por simple información, al objeto de hacer comprender sin dificultad a qué cerraduras van destinadas nuestras llaves.

Este catálogo está reservado exclusivamente a los profesionales de la reproducción de llaves que utilizan los productos Silca.

P IMPORTANTE

Em conformidade com as disposições legais em vigor relativas à propriedade industrial, informamos que as marcas ou as denominações comerciais citadas no nosso catálogo são propriedade exclusiva dos fabricantes de fechaduras e dos utilizadores autorizados.

Estas marcas ou denominações comerciais são indicadas só a nível de informação, a fim de reconhecer rapidamente a quais fechaduras se destinam as nossas chaves.

Este catálogo é reservado exclusivamente aos profissionais da reprodução de chaves que utilizam os produtos Silca.